

# 12VDC CONSTANT VOLTAGE DRIVER

# SPECIFICATION SHEET

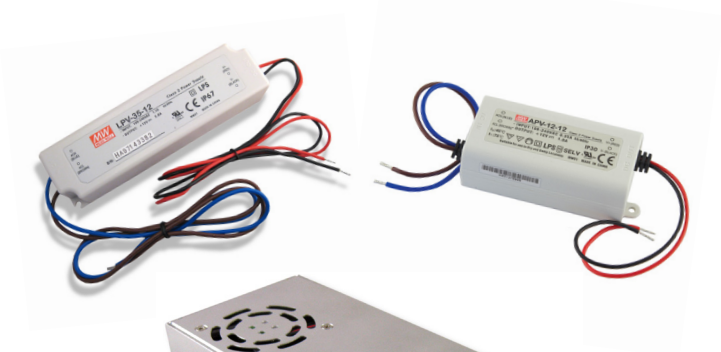

## OVERVIEW

12VDC Constant Voltage LED Drivers are the driver of choice to pair with 120V switches, low voltage REIGN<sup>®</sup> Dimmers, and RGB(W)/DMX Controls. These hard-wired drivers are available in multiple form factors and voltage/wattage combinations to meet your low-voltage LED lighting needs. Note: only specific models may be paired with REIGN<sup>®</sup> Dimmers and RGB(W)/DMX controls.

## FEATURES

- Available in wattages from 12W to 300W
- Short circuit, over current, over voltage, over temperature protections
- Class 2 power unit models available
- Fanless design models available
- UL Recognized Component (driver only)
- UL Listed models available (LO-PRO<sup>®</sup> Junction Box & Driver Combo)

RECEIVE A UL LISTED DRIVER WHEN ORDERING THE LO-PRO<sup>®</sup> JUNCTION BOX & DRIVER COMBO ON PAGE 2.



Item #	
Project	

# SPECIFICATIONS - 12VDC Output Models

## LO-PRO® JUNCTION BOX & DRIVER COMBO

**UL LISTED DRIVER OPTION**





SKUs highlighted in blue qualify for the Lo-Pro Junction Box & Driver Combo. An additional UL Listed E469769 Sticker will be placed on the outside of the Lo-Pro J-Box certifying the combo as a UL Listed Low Voltage Power unit. Conforms to Article 725.121(A)(2) of the National Electrical Code®.

	DI-0904	DI-0904-LPS	DI-0918	DI-0918-LPS	DI-0906	DI-0906-LPS
<b>Input Voltage / Frequency<sup>1</sup></b>	90 ~ 264VAC / 47 ~ 63Hz (Refer to 'Static Characteristics Curve')					
<b>Max Load</b>	20W / 1.67A (See Derating Curve)		35W / 2.92A (See Derating Curve)		60W / 5.0A (See Derating Curve)	
<b>Class 2 Certified</b>	Yes		Yes		Yes	
<b>Output Voltage</b>	12VDC		12VDC		12VDC	
<b>Compatible Junction Boxes</b>	LO-PRO® J-Box (Small) DI-JBOX-LPS	UL Listed Combo includes J-Box	LO-PRO® J-Box (Small) DI-JBOX-LPS	UL Listed Combo includes J-Box	LO-PRO® J-Box (Small) DI-JBOX-LPS	UL Listed Combo includes J-Box
<b>Ambient Temperature<sup>2</sup></b>	-22 ~ 158°F (-30 ~ +70°C)					
<b>Operating Temperature<sup>3</sup></b>	-22 ~ 158°F (-30 ~ +70°C)					
<b>Minimum Load</b>	None		None		None	
<b>Dimmability<sup>4</sup></b>	Yes. PWM & RGB(W) dimmers/controls & DMX controls					
<b>Input Current Full Load</b>	0.55A@115VAC, 0.35A@230VAC		1.1A@115VAC, 0.7A@230VAC		1.2A@115VAC, 1.0A@230VAC	
<b>Primary Leads</b>	UL 1015 18/2AWG, AC/L (Brown), AC/N (Blue), No FG connection (Class II)		UL 1015 18/2AWG, AC/L (Brown), AC/N (Blue), No FG connection (Class II)		UL 1015 18/2AWG, AC/L (Brown), AC/N (Blue), No FG connection (Class II)	
<b>Secondary Leads</b>	UL 1015 18/2AWG, V+(Red), V-(Black)		UL 1007 16/2AWG, V+(Red), V-(Black)		UL 1007 16/2AWG, V+(Red), V-(Black)	
<b>Voltage Boost</b>	No		No		No	
<b>Circuit Breakers</b>	Auto Reset Hiccup		Auto Reset Hiccup		Auto Reset Hiccup	
<b>Efficiency</b>	81%		84%		83%	
<b>Environment<sup>5</sup></b>	IP 67 (Driver Only) Outdoor / Wet	Indoor / Dry	IP 67 (Driver Only) Outdoor / Wet	Indoor / Dry	IP 67 (Driver Only) Outdoor / Wet	Indoor / Dry
<b>Working Humidity</b>	20 ~ 90% RH non-condensing		20 ~ 90% RH non-condensing		20 ~ 90% RH non-condensing	
<b>Housing / Cooling</b>	Plastic Class II power unit, no FG connection / free air convection	Powder-coated Steel / free air convection	Plastic Class II power unit, no FG connection / free air convection	Powder-coated Steel / free air convection	Plastic Class II power unit, no FG connection / free air convection	Powder-coated Steel / free air convection
<b>Dimensions</b>	4.65 x 1.38 x 1.2 in. (L x W x H)	11.25 x 3.75 x 1.90 in. (L x W x H)	5.83 x 1.57 x 1.18 in. (L x W x H)	11.25 x 3.75 x 1.90 in. (L x W x H)	6.40 x 1.67 x 1.26 in. (L x W x H)	13.5 x 4.50 x 3.75 in. (L x W x H)
<b>Weight</b>	0.48 lbs (7.76 oz.)	2.38 lbs (38.08 oz.)	0.75 lbs (12 oz.)	2.65 lbs (42.4 oz.)	0.88 lbs (14.12 oz.)	3.58 lbs (42.4 oz.)
<b>Warranty</b>	2 Years	Driver: 2 Years J-Box: 5 Years	2 Years	Driver: 2 Years J-Box: 5 Years	2 Years	Driver: 2 Years J-Box: 5 Years
<b>Certifications</b>	cULus R/C 1310, CSA C22.2 No. 223-M91. CE Certified.	cULus Listed 1598 E469769. UL 1310, CSA C22.2 No. 223-M91. CE Certified.	cULus R/C 1310, CSA C22.2 No. 223-M91. CE Certified.	cULus Listed 1598 E469769. UL 1310, CSA C22.2 No. 223-M91. CE Certified.	cULus R/C 1310, CSA C22.2 No. 223-M91. CE Certified.	cULus Listed 1598 E469769. UL 1310, CSA C22.2 No. 223-M91. CE Certified.

See Page 5 for Important Notes.



## SPECIFICATIONS CONT. - 12VDC Output Models

	DI-0941	DI-0939	DI-DV-12V60W-277
			
<b>Input Voltage / Frequency<sup>1</sup></b>	90 ~ 264VAC / 47 ~ 63Hz (Refer to 'Static Characteristics Curve')	88 ~ 264VAC / 47 ~ 63Hz (Refer to 'Static Characteristics Curve')	<b>100 ~ 277VAC, 50/60Hz</b>
<b>Max Load</b>	12W / 1.0A (See Derating Curve)	25W / 2.08A (See Derating Curve)	60W / 5.0A
<b>Class 2 Certified</b>	Yes	No	Yes
<b>Output Voltage</b>	12VDC	12VDC	12VDC
<b>Compatible Junction Boxes</b>	Fits in standard 4 x 4 x 2 in. electrical boxes	Fits in standard 4 x 4 x 2 in. electrical boxes	*LO-PRO® Junction Box (Large) DI-JBOX-LPL
<b>Ambient Temperature<sup>2</sup></b>	-22 ~ 158°F (-30 ~ +70°C)	-4 ~ 158°F (-20 ~ +70°C)	-40 ~ +122°F (-40 ~ +50°C)
<b>Operating Temperature<sup>3</sup></b>	-22 ~ 158°F (-30 ~ +70°C)	-4 ~ 158°F (-20 ~ +70°C)	-40 ~ +194°F (-40 ~ +90°C)
<b>Minimum Load</b>	None	None	None
<b>Dimmability<sup>4</sup></b>	Yes. PWM & RGB(W) dimmers/controls & DMX controls	No. On/Off Switching Only	Yes. PWM & RGB(W) dimmers/controls & DMX controls
<b>Input Current Full Load</b>	0.35A@115VAC, 0.2A@230VAC	0.7A@115VAC, 0.4A@230VAC	6.1A@120VAC 2.7A@277VAC
<b>Primary Leads</b>	UL 1569 18/2AWG, AC/L (Brown), AC/N (Blue), No FG connection (Class II)	Terminal Block w/ framed ground connection	UL STJW 18/3AWG, AC/L (Black), AC/N (White), GND (Green)
<b>Secondary Leads</b>	UL 1569 20/2AWG, V+(Red), V-(Black)	Terminal Block	UL STJW 18/2AWG, V+(Red), V-(Black)
<b>Voltage Boost</b>	No	Yes. Voltage Adjustment Dial: 10.8 ~ 13.2V	No
<b>Circuit Breakers</b>	Auto Reset Hiccup	Auto Reset Hiccup	Auto Reset Hiccup
<b>Efficiency / Power Factor Full Load</b>	82%	81.5%	87% / PF>0.95
<b>Environment</b>	IP 42 / Indoor / Dry Location	Indoor / Dry Location. Install in a dust-free environment.	IP 67 (driver only) Outdoor / Wet
<b>Working Humidity</b>	20 ~ 90% RH non-condensing	20 ~ 90% RH non-condensing	20 ~ 90% RH non-condensing
<b>Housing / Cooling</b>	Plastic Class II power unit, no FG connection / free air convection	Aluminum / free air convection	Aluminum / free air convection
<b>Dimensions</b>	3.54 x 1.57 x 1.14 in. (L x W x H)	3.07 x 2.01 x 1.10 in. (L x W x H)	9.50 x 1.70 x 1.14 in. (L x W x H)
<b>Weight</b>	0.175 lbs (2.8 oz.)	0.44 lbs (7.05 oz.)	1.32 lbs. (21.12 oz.)
<b>Warranty</b>	2 Years	3 Years	5 Years
<b>Certifications</b>	cULus Recognized Component 8750, CSA C22.2 No. 250.0-08. CE Certified. SELV. LPS. ENEC Certified.	cULus Recognized Component 60950-1. CE Certified.	cULus Recognized Component 1310. UL # E332747. FCC Compliant. RoHS Compliant.

\* LO-PRO® Junction Box Note: Driver will fit in LO-PRO Junction Box indicated in the field **Compatible Junction Boxes** but is not available as a UL Listed LO-PRO Junction Box & Driver Combo.

See Page 5 for Important Notes.

## SPECIFICATIONS CONT. - 12VDC Output Models

	DI-CV-12V120W	DI-0908	DI-0909
			
<b>Input Voltage / Frequency<sup>1</sup></b>	90 ~ 132VAC / 47 ~ 63Hz (Refer to 'Static Characteristics Curve')	85 ~ 264VAC / 47 ~ 63Hz (Refer to 'Static Characteristics Curve')	85 ~ 264VAC, 50/60Hz (Refer to 'Static Characteristics Curve')
<b>Max Load</b>	120W / 10A	150W / 12.5A	200W / 16.67A
<b>Class 2 Certified</b>	No	No	No
<b>Output Voltage</b>	12VDC	12VDC	12VDC
<b>Compatible Junction Boxes</b>	*LO-PRO® Junction Box (Large) DI-JBOX-LPL	Meanwell™ Junction Box: DI-0940 Mounting Brackets (for driver only): DI-1733	Meanwell™ Junction Box: DI-0940 Mounting Brackets (for driver only): DI-1733
<b>Ambient Temperature<sup>2</sup></b>	-13 ~ +149°F (-25 ~ +65°C)	+14 ~ +131°F (-10 ~ +55°C)	+14 ~ +140°F (-10 ~ +60°C)
<b>Operating Temperature<sup>3</sup></b>	-13 ~ +149°F (-25 ~ +65°C)	+14 ~ +131°F (-10 ~ +55°C)	+14 ~ +140°F (-10 ~ +60°C)
<b>Minimum Load</b>	None	None	None
<b>Dimmability<sup>4</sup></b>	Yes. PWM & RGB(W) dimmers/controls & DMX controls	On/Off Switching Only	On/Off Switching Only
<b>Input Current Full Load</b>	3.0A@115VAC	2.5A@115VAC 1.2A@230VAC	3.5A@115VAC 1.7A@230VAC
<b>Primary Leads</b>	SJTW 18/2AWG, AC/L (Brown), AC/N (Blue)	Terminal block w/ framed ground connection	Terminal block w/ framed ground connection
<b>Secondary Leads</b>	SJTW 14/2AWG, V+(Red), V-(Black)	Terminal Block	Terminal Block
<b>Voltage Boost</b>	No	Yes. Voltage Adjustment Dial: 11.4 ~ 13.2V	Yes. Voltage Adjustment Dial: 11.4 ~ 13.2V
<b>Circuit Breakers</b>	Auto Reset Hiccup	Auto Reset Hiccup	Auto Reset Hiccup
<b>Efficiency / Power Factor Full Load</b>	88%	84% / PF>0.97@115VAC / PF>0.93@240VAC	84% / PF>0.97@115VAC / PF>0.93@240VAC
<b>Environment</b>	IP67 (driver only) Outdoor / Wet	Indoor / Dry Location. Install in a dust-free environment.	Indoor / Dry Location. Install in a dust-free environment.
<b>Working Humidity</b>	20 ~ 90% RH non-condensing	20 ~ 90% RH non-condensing	20 ~ 90% RH non-condensing
<b>Housing / Cooling</b>	Plastic Class II power unit, no FG connection / free air convection	Aluminum / free air convection	Aluminum / built-in cooling fan
<b>Dimensions</b>	7.52 x 2.5 x 1.48 in. (L x W x H)	8.30 x 3.90 x 2.00 in (L x W x H)	8.30 x 3.90 x 2.00 in (L x W x H)
<b>Weight</b>	1.88 lbs. (30 oz.)	1.68 lbs. (26.88 oz.)	1.87 lbs. (29.92 oz.)
<b>Warranty</b>	2 Years	3 Years	3 Years
<b>Certifications</b>	cULus Recognized Component 8750, CSA C22.2 No. 250.0-08. Listed in UL Sign Component Manual (SAM). FCC Compliant.	cULus Recognized Component 60950-1. CE Certified.	cULus Recognized Component 60950-1. CE Certified.

\* LO-PRO® Junction Box Note: Driver will fit in LO-PRO Junction Box indicated in the field **Compatible Junction Boxes** but is not available as a UL Listed LO-PRO Junction Box & Driver Combo.

See Page 5 for Important Notes.

## SPECIFICATIONS CONT. - 12VDC Output Models

	DI-0928
	
<b>Input Voltage / Frequency<sup>1</sup></b>	85 ~ 264VAC / 47 ~ 63Hz (Refer to 'Static Characteristics Curve')
<b>Max Load</b>	300W / 25A
<b>Class 2 Certified</b>	No
<b>Output Voltage</b>	12VDC
<b>Compatible Junction Boxes</b>	No compatible J-Box. Mounting Brackets (for driver only): DI-1733
<b>Ambient Temperature<sup>2</sup></b>	-40 ~ +158°F (-40 ~ +70°C)
<b>Operating Temperature<sup>3</sup></b>	-40 ~ +158°F (-40 ~ +70°C)
<b>Minimum Load</b>	None
<b>Dimmability<sup>4</sup></b>	Yes. PWM & RGB(W) dimmers/controls & DMX controls
<b>Input Current Full Load</b>	3.5A@115VAC 1.8A@230VAC
<b>Primary Leads</b>	Terminal block w/ framed ground connection
<b>Secondary Leads</b>	Terminal Block
<b>Voltage Boost</b>	Yes. Voltage Adjustment Dial: 10.2 ~ 13.8V
<b>Circuit Breakers</b>	Auto Reset Hiccup
<b>Efficiency / Power Factor Full Load</b>	88% / PF>0.99@115VAC / PF>0.95@230VAC
<b>Environment</b>	Indoor / Dry Location. Install in a dust-free environment.
<b>Working Humidity</b>	20 ~ 90% RH non-condensing
<b>Housing / Cooling</b>	Aluminum / built-in cooling fan
<b>Dimensions</b>	8.5 x 4.13 x 1.61 in. (L x W x H)
<b>Weight</b>	2.09 lbs. (33.44 oz.)
<b>Warranty</b>	5 Years
<b>Certifications</b>	cULus Recognized Component 60950-1. CE Certified.

### Notes

1. Refer to the 'Static Characteristics Curve' if installing under low input voltage conditions to properly derate the power supply load
2. Refer to the 'Derating Curve' if nearing max. ambient temperature to properly derate the power supply load. Do not install product in an environment outside the listed ambient temperature.
3. Operating temperature is measured according to the minimum and maximum ambient temperature environment. Operating temperature is measured according to the minimum and maximum ambient temperature environment.
4. Not compatible with 120VAC dimming controls. PWM dimmer/control spec sheet will indicate if multiple controls can be paired to a single driver.
5. Varies per model. Some models (driver only) are suitable for wet location but must be installed in a wet location J-Box. Lo-Pro J-Box & Driver Combo is suitable for indoor / dry locations but also suitable for wet location when the full combo is installed in a wet location J-Box.

### DERATING CURVE

12V 12W - DI-0941

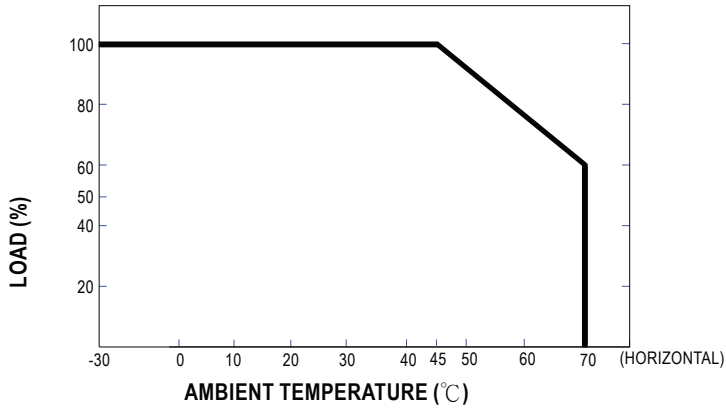

### STATIC CHARACTERISTICS CURVE

12V 12W - DI-0941

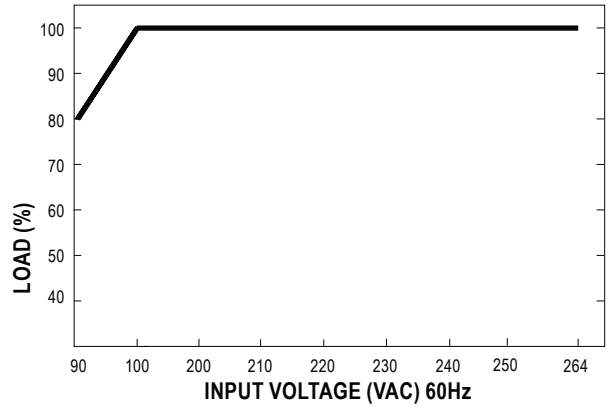

12V 20W - DI-0904 / DI-0904-LPS

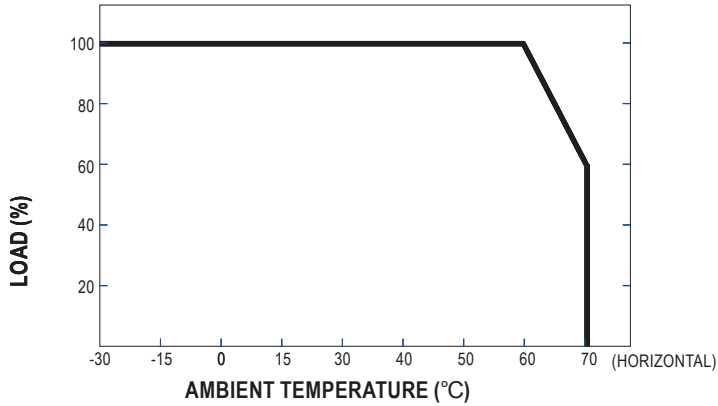

12V 20W - DI-0904 / DI-0904-LPS

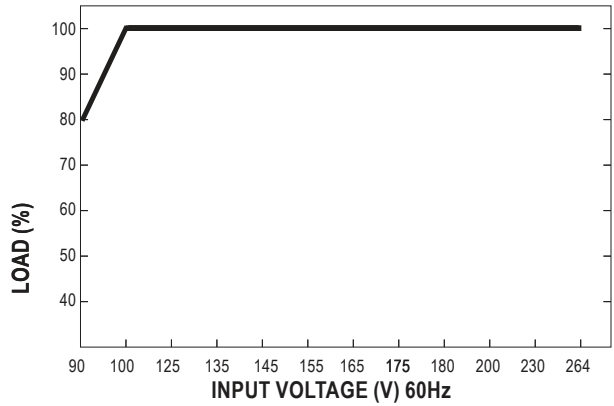

12V 25W - DI-0939

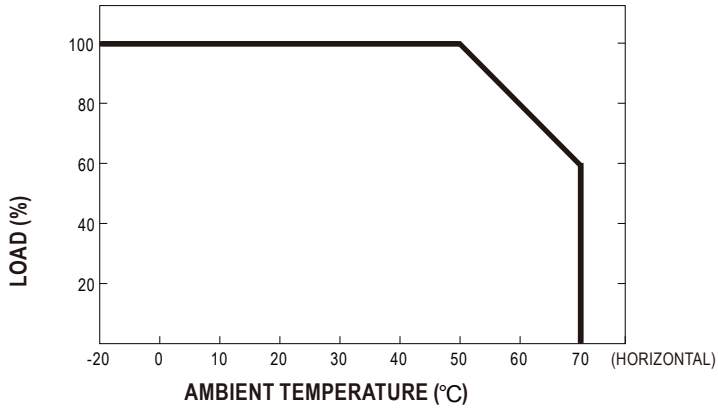

12V 25W - DI-0939

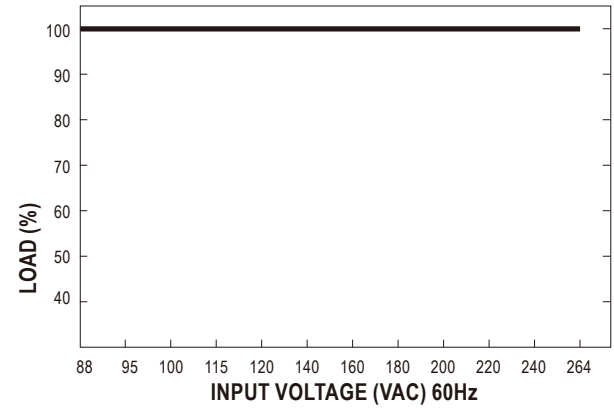

12V 35W - DI-0918 / DI-0918-LPS

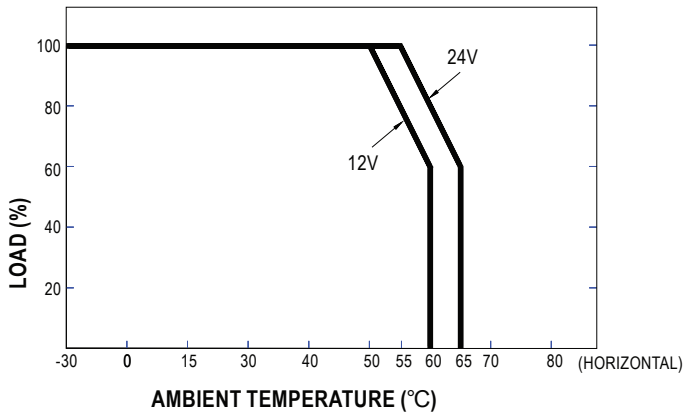

12V 35W - DI-0918 / DI-0918-LPS

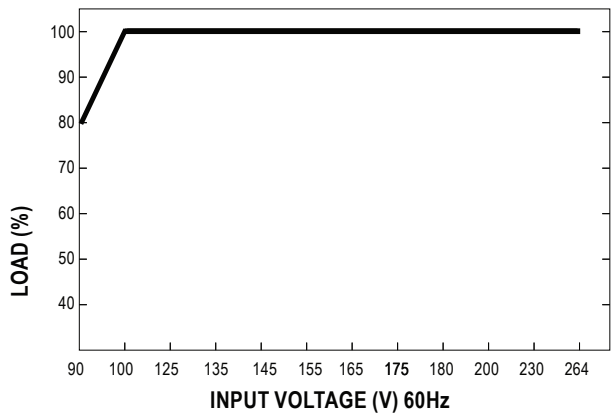

### DERATING CURVE CONT.

12V 60W - DI-0906 / DI-0906-LPS

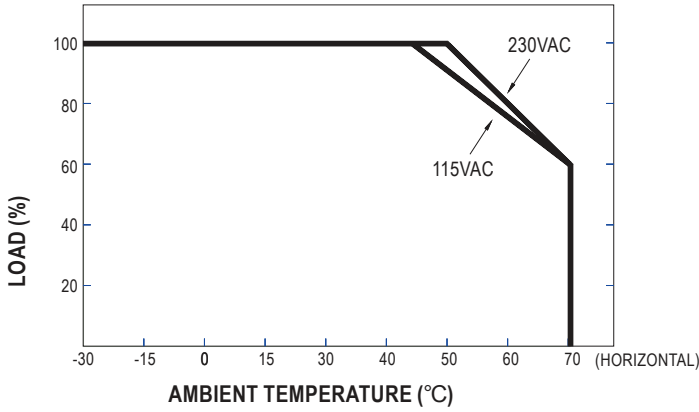

### STATIC CHARACTERISTICS CURVE CONT.

12V 60W - DI-0906 / DI-0906-LPS

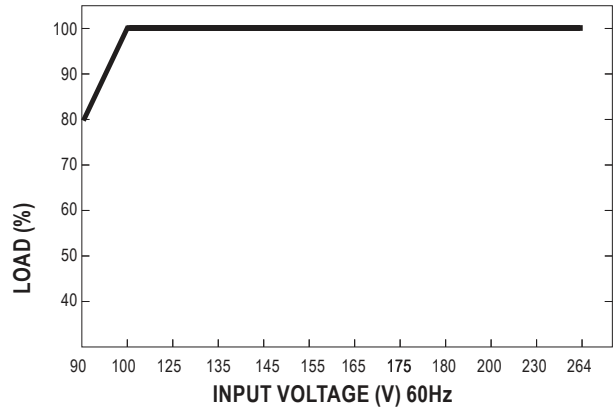

12V 120W - DI-CV-12V120W

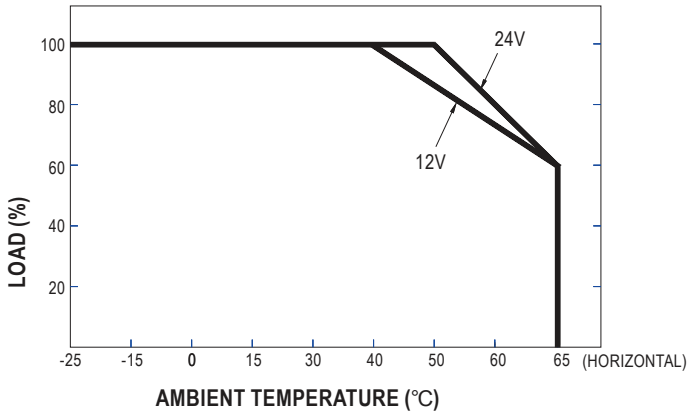

12V 120W - DI-CV-12V120W

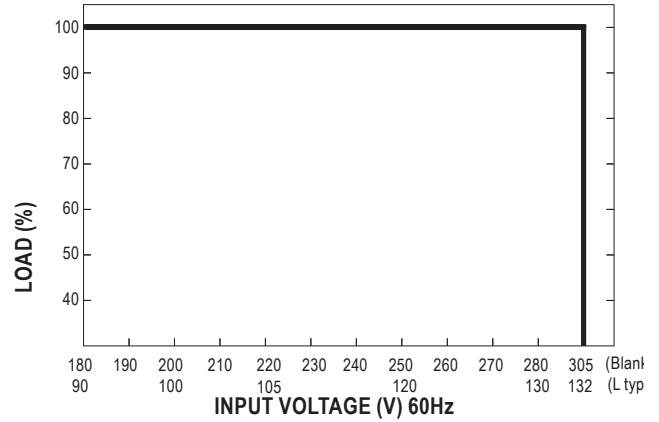

12V 150W - DI-0908

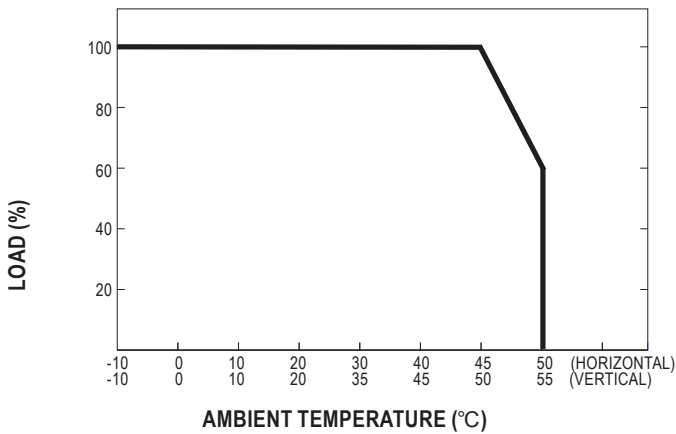

12V 150W - DI-0908

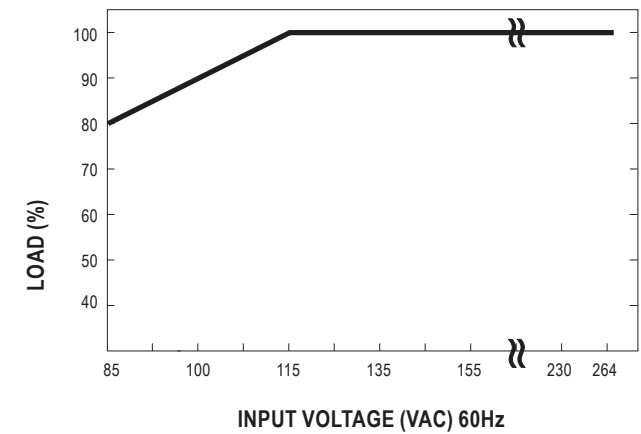

12V 200W - DI-0909

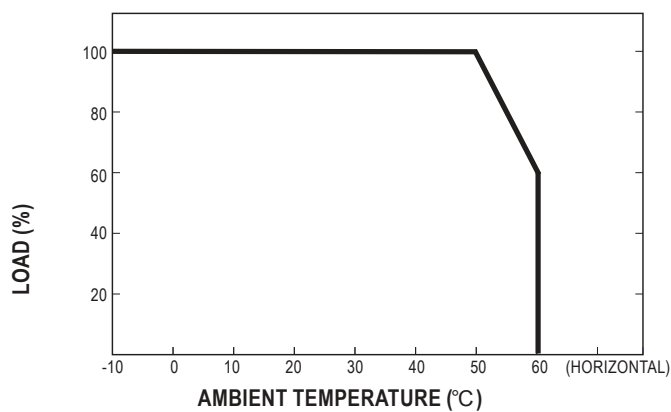

12V 200W - DI-0909

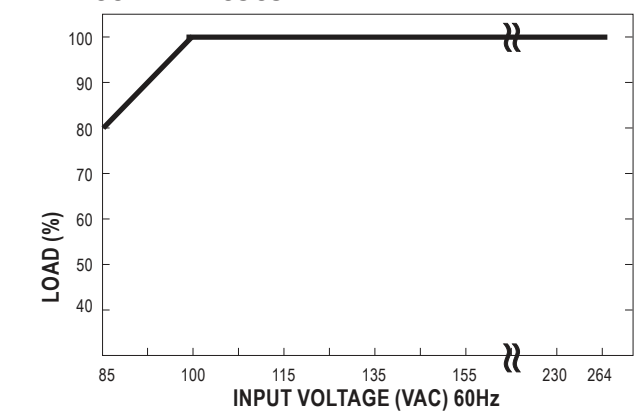

**DERATING CURVE CONT.**

**12V 300W - DI-0928**

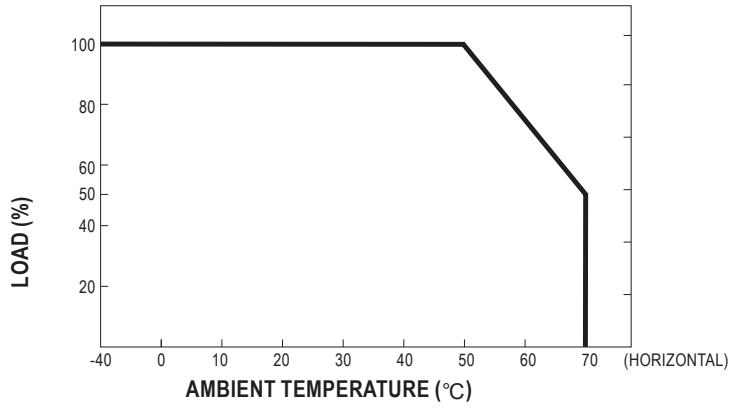

**STATIC CHARACTERISTICS CURVE CONT.**

**12V 300W - DI-0928**

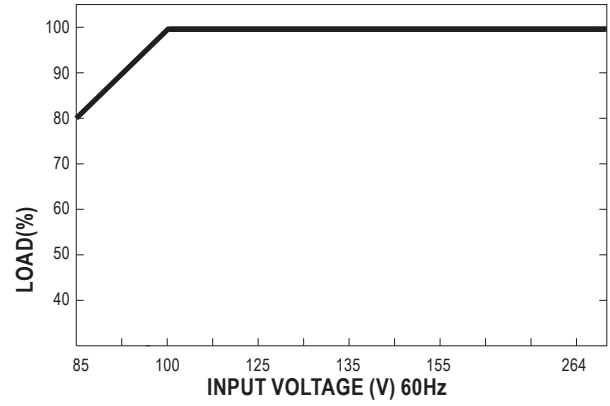

**MECHANICAL DIAGRAMS** *(Images are not to scale)*

**LO-PRO® JUNCTION BOX & DRIVER COMBO**

12V 20W - DI-0904-LPS

12V 35W - DI-0918-LPS

12V 60W - DI-0906-LPS

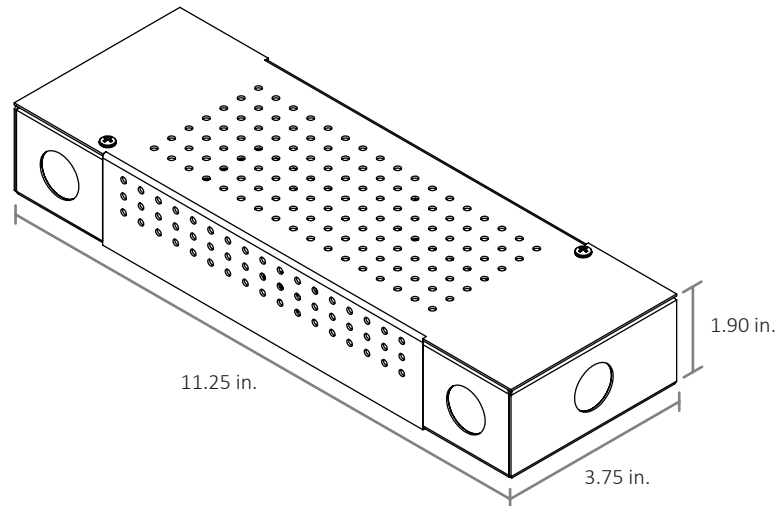

**12V 12W - DI-0941**

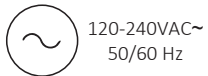

AC/N(Blue)  
AC/L(Brown)

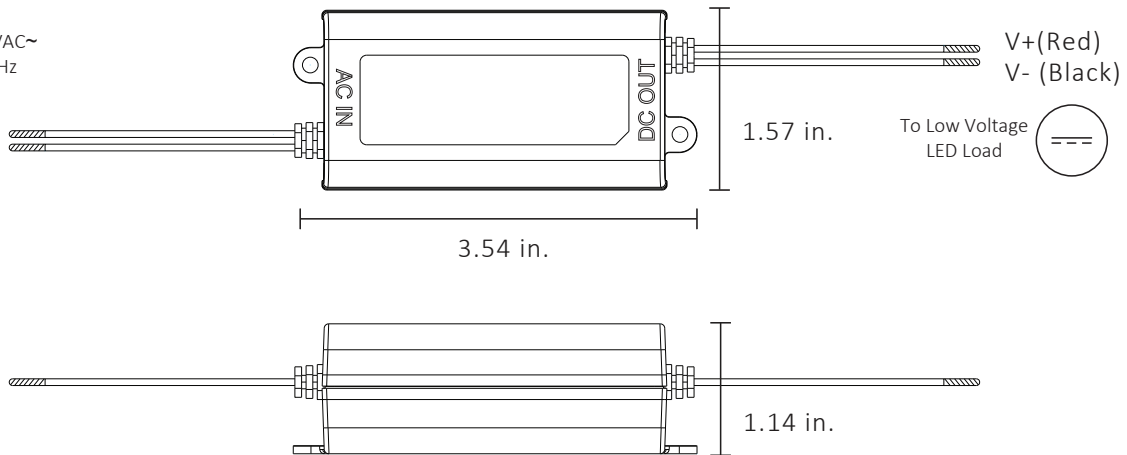



**MECHANICAL DIAGRAMS** *(Images are not to scale)*

**12V 20W - DI-0904**

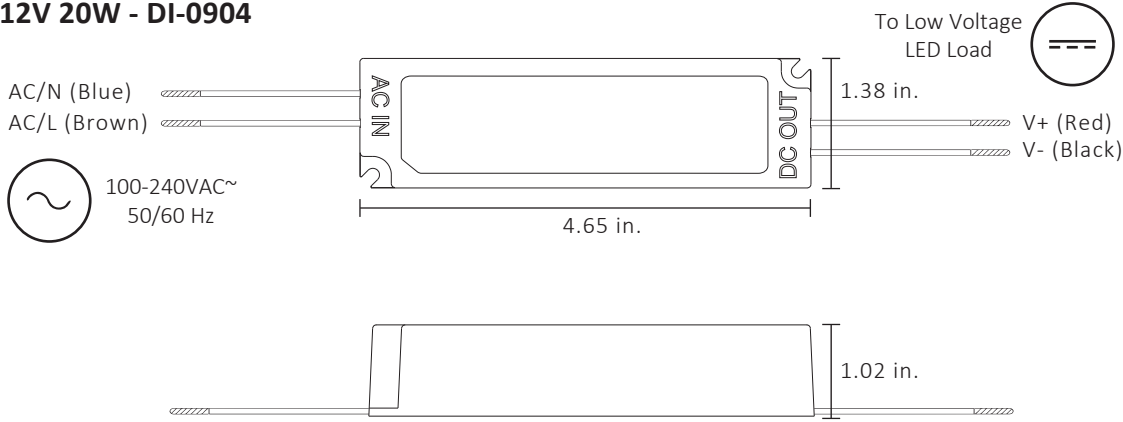

**12V 25W - DI-0939**

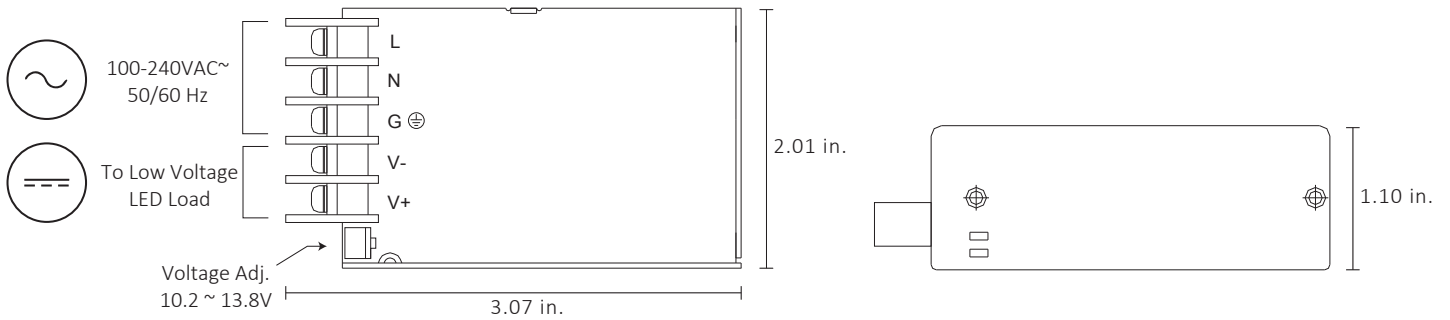

**12V 35W - DI-0918**

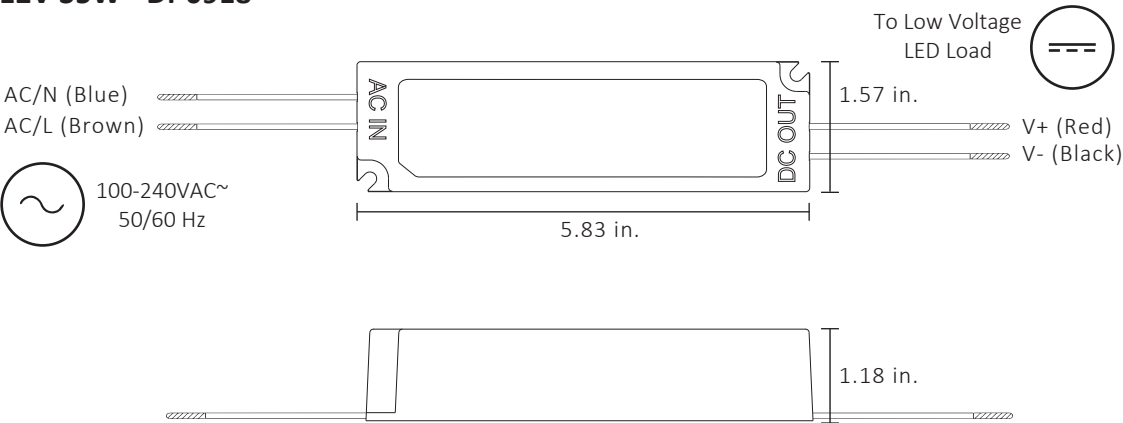

**12V 60W - DI-0906**

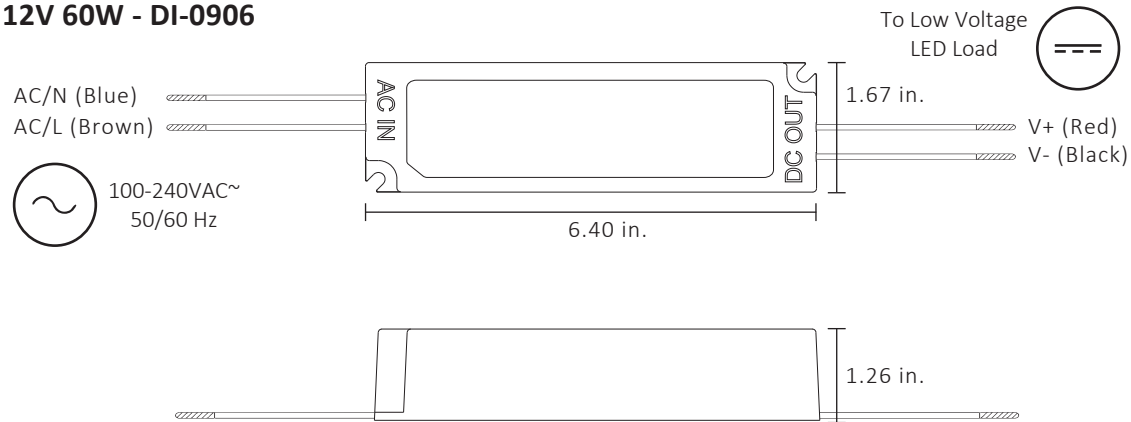

# MECHANICAL DIAGRAMS *(Images are not to scale)*

## 12V 60W - DI-DV-12V60W-277

AC/N (White)  
AC/L (Black)

120-277VAC~  
50/60 Hz

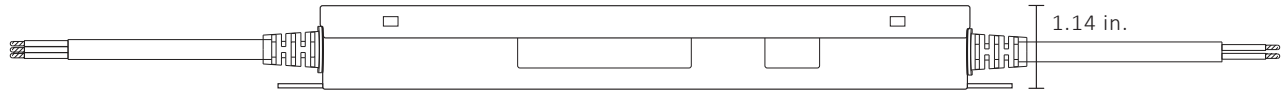
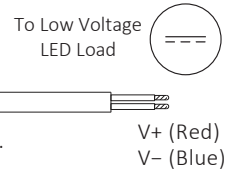
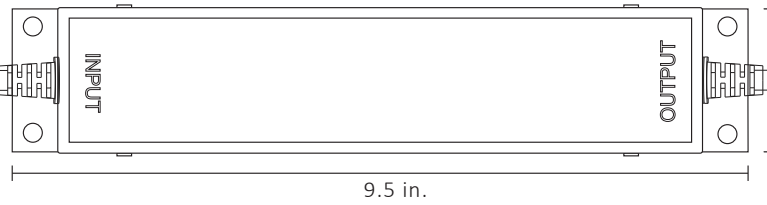

## 12V 120W - DI-CV-12V120W

AC/N (Blue)  
AC/L (Brown)

90-132VAC~  
50/60 Hz

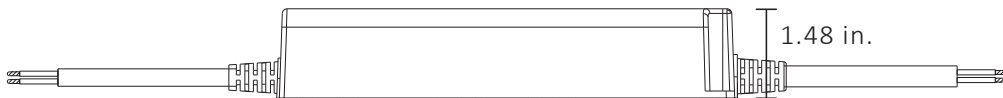
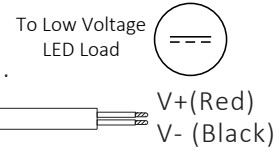
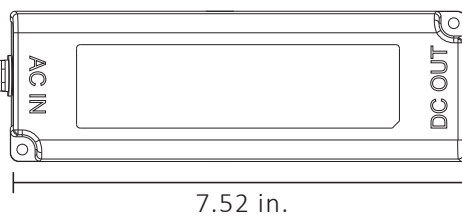

## 12V 150W - DI-0908

Voltage Adj.  
11.4 ~ 13.2V



100-240VAC~  
50/60 Hz

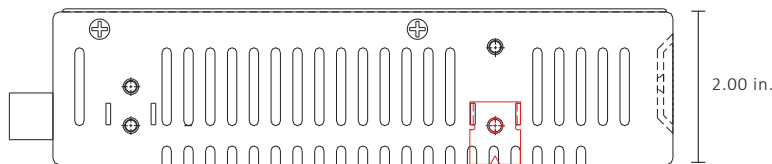
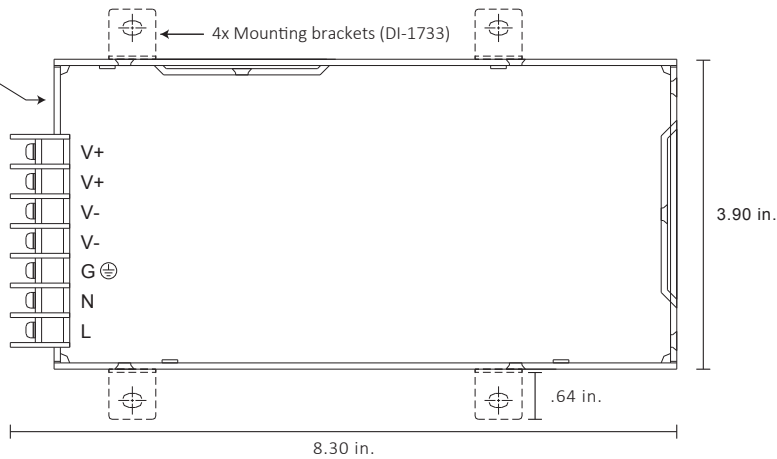

4x Mounting brackets/hardware (sold separately). Hardware Size: M4 L=6.  
Use applicable screws to mount driver/brackets to desired surface.

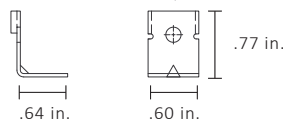

# MECHANICAL DIAGRAMS

## 12V 200W - DI-0909

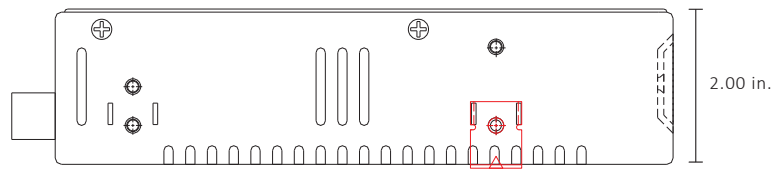
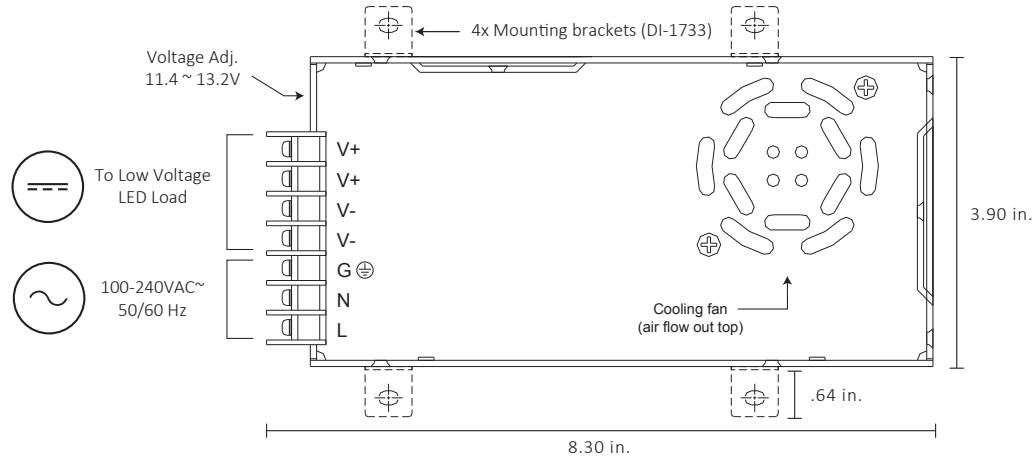

4x Mounting brackets/hardware (sold separately). Hardware Size: M4 L=6. Use applicable screws to mount driver/brackets to desired surface.

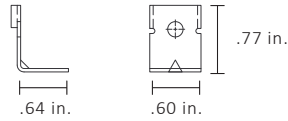

## 12V 300W - DI-0928

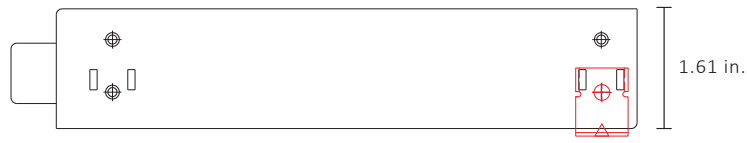
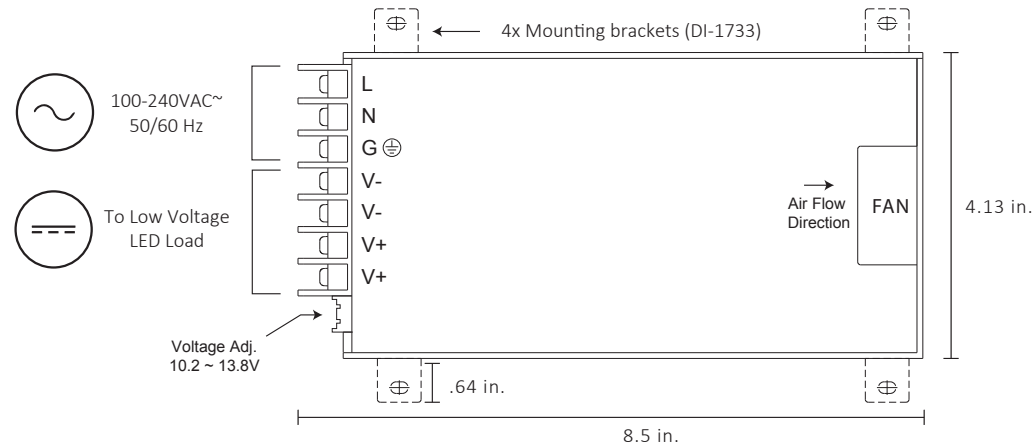

4x Mounting brackets/hardware (sold separately). Hardware Size: M4 L=6. Use applicable screws to mount driver/brackets to desired surface.

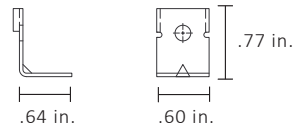

## ADDITIONAL RESOURCES

24VDC CONSTANT VOLTAGE DRIVER Specification Sheet  
12VDC COMMERCIAL GRADE CV DRIVER Specification Sheet  
24VDC COMMERCIAL GRADE CV DRIVER Specification Sheet  
LO-PRO JUNCTION BOX Specification Sheet  
LO-PRO JUNCTION BOX Installation Guide  
Voltage Drop Charts

## SAFETY / WARNINGS / DISCLOSURES

1. Install in accordance with national and local electrical code regulations.
2. This product is intended to be installed and serviced by a qualified, licensed electrician.
3. DO NOT modify product beyond instructions or warranty will be void.
4. Turn power OFF at main breaker before servicing or installing this product.
5. Proper heat dissipation will prolong the working lifespan of this product. Install in a well-ventilated area free from explosive gases and vapors.
6. Refer to the 'Static Characteristics Curve' if installing under low input voltage conditions to properly derate the power supply load
7. Refer to the 'Derating Curve' if nearing max. ambient temperature to properly derate the power supply load. Do not install product in an environment outside the listed ambient temperature.
8. Ensure a compatible LED fixture with the correct operating voltage is installed with this product.
9. Drivers in this specification sheet are not compatible with 120VAC dimming controls. Some models are compatible with PWM/RGB(W) and DMX Controls. The PWM dimmer/control spec sheet will indicate if multiple controls can be paired to a single driver.
10. To compensate for voltage drop, ensure applicable gauge in-wall rated wire is installed between driver and LED fixture.
11. Some models (driver only) are suitable for wet location but must be installed in a wet location J-Box. Lo-Pro J-Box & Driver Combo is suitable for indoor / dry locations but also suitable for wet location when the full combo is installed in a wet location J-Box.

## WARRANTY

### Limited Warranty

The limited warranty of this product begins from the date of shipment. The warranty of each item can be found in the 'Specifications' chart under 'Warranty'. This warranty does not include the additional accessories referenced in this specification sheet. Complete warranty details for fixtures and additional accessories are available at [www.diodeled.com/limited-warranty/](http://www.diodeled.com/limited-warranty/) within the Policies section. For warranty related questions please contact product support.

### Consumer's Acknowledgment

Diode LED stands behind its products when they are used properly and according to our specifications. By purchasing our products, the purchaser agrees and acknowledges that lighting design, configuration and installation is a complex process, wherein seemingly minor factors or changes in layout and in-field adjustments can have a significant impact on an entire system. Choosing the correct components is essential. Diode LED is able to work with the original purchaser to make an appropriate product selection to the extent of the limited information that the customer can provide, but it is virtually impossible for Diode LED to design a system that foresees every unknown factor. For this reason, this Warranty does not cover problems caused by improper design, configuration or installation issues. Any statement from a Diode LED employee or agent regarding a customer's bill of goods and/or purchase order is NOT an acknowledgment that the products purchased are designed and configured correctly. The purchase agrees and acknowledges that it is the customer's responsibility to adhere strictly to all information contained in the Product Specification Sheets.

There is often more than one way to design, configure and layout an LED lighting application properly to achieve the same lighting effect. Diode LED strongly recommends that licensed professionals be used in the design and installation of lighting systems that include Diode LED products. The specifications include important information that a designer and installer should carefully review and strictly follow. Qualified designers and certified and/or licensed installers, with access to the final installation environment, customer goals, and Diode LED product specifications can make the requisite decisions appropriate for a successful finished lighting application.



© 2017 Elemental LED, Inc. All rights reserved.  
Specifications are subject to change without notice.

Toll Free: 877.817.6028 | Fax: 415.592.1596 | [www.DiodeLED.com](http://www.DiodeLED.com) | [info@DiodeLED.com](mailto:info@DiodeLED.com)