

LED Panels: BackLit Line

5-CCT & 3-Power Selectable

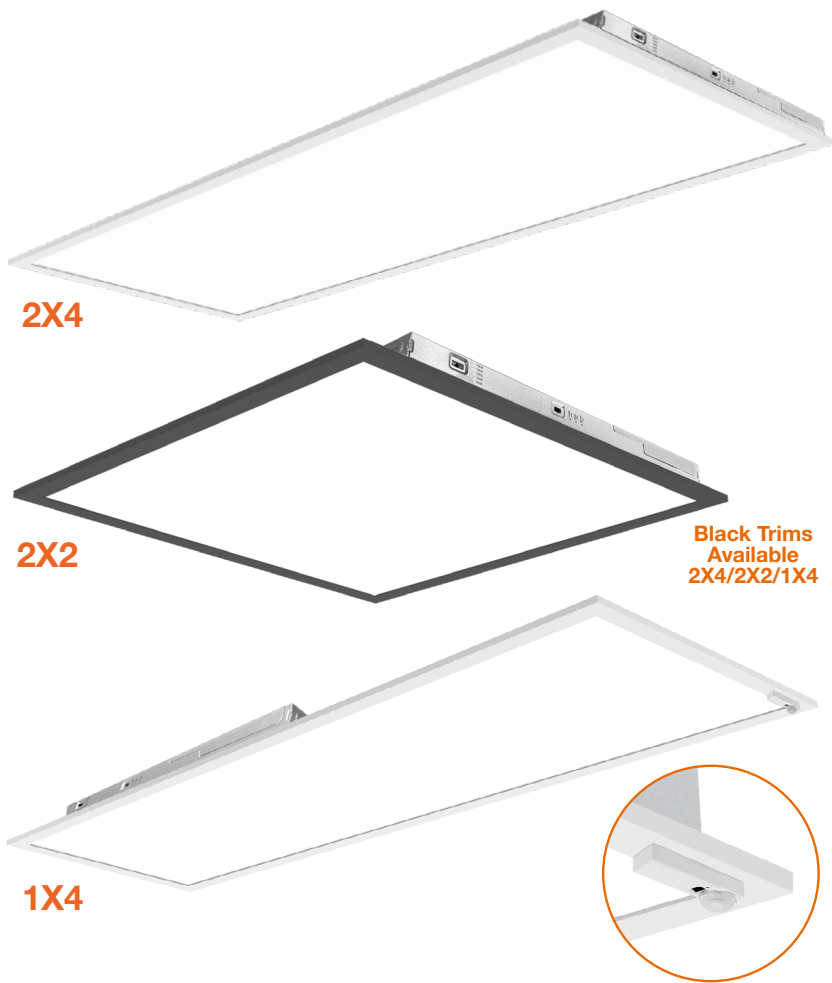

Black Trims Available
2X4/2X2/1X4

Shown with
Sensor Option

Regular Versions		HL Versions	
WATT	LUMENS	WATT	LUMENS
20	2,200	30	3,750
30	3,300	40	5,000
40	4,400	45	5,625
50	5,500	50	6,250
		55	6,875
		65	8,125

Detail Specifications:

- Finish: White, Custom finishes available
- IP Rating: Damp Location (IP44)
- 5CCT: 30/35/40/50/65K
- Beam Angle: 110°
- Chip: SMD 2835, R9 >50, CRI >80
- Operating Temperature: -40° - 114° F
- Lens: PS (polystyrene) frosted, non-yellowing, & shatter resistant
- Average life (L70) of 50,000 hours
- IC Rated

Applications:

- General Indoor Lighting
- Utility & Storage
- Garage Structures
- Office and Meeting Rooms
- Education, Healthcare, Retail, Hospitality
- Commercial and Industrial

Product Information:

- Metal housing finished with corrosion free power coat
- Even light distribution
- Lightweight for easier installation
- Select-n-Switch Technology: 5-CCT + 3-Power Selectable
- Control Options:
 - Standard Sensors
 - SILVAIR Bluetooth Mesh
 - ENVISIONLS Bluetooth
 - [Click Here](#) for More Information

Driver Options:

- UNV: 120-277V 0-10V Dimmable (Dim to Off)
- Optional 347-480V step down transformer available
- Standard EMB used:
 - 40W: 8W EMB ([LED-EMB-8W-HV-0-10V-2P](#))
 - 50W: 15W EMB ([LED-EMB-15W-HV-0-10V-2P](#))
- Higher wattage emb (up to 25W) available by request. Pricing will vary.
- THD: <15% (+/-5% tolerance), PF >0.9, 50/60Hz
- Isolated Driver
- Flicker Free

Mounting & Installations:

- Lay-in ceilings for 5/8" and 3/8" ceiling widths
- Built-in earthquake clips
- Optional 9' suspension kit available
- Optional surface mount, drywall kit available
- Use surface mount and suspension kit for an aesthetically pleasing design

Certifications:

- ETL Listed for USA and CA
- DLC Listed/ DLC Premium Listed (HL Versions)
 - View DLC ID Chart below
- NSF Rated
- Approved for CA T24
- 5 Year Limited Warranty

Series	Sensor	Emergency Driver ¹		Whip
LED-BPL-2X2-3M40-5CCT 20/30/40W	(blank) No Sensor	(blank) No	(blank) 120-277V	(blank) No Whip
LED-BPL-2X2-3M50-5CCT-HL 30/40/50W	SR Sensor Ready (See sensor options)	Emergency EMB	HV 347-480V Stepdown	-6FLX 6' Flex
LED-BPL-2X4-3M50-5CCT 30/40/50W		Emergency Backup		
LED-BPL-2X4-3M65-5CCT-HL 45/55/65W				
LED-BPL-1X4-3M40-5CCT 20/30/40W				

1. HV: High voltage is made to order.

Optional Accessories (Order Separately)

Sensors	Suspension Kits	Surface ¹ Mount Kits		Color Trims
		Drywall Kits		
S-AUD-PIR-1 PIR Bi-Level Motion + Daylight Sensor Remote Required: (S-LINE-R)	SK-10FT-Y-LC-CB 10' Suspension Kit	2X2-SM-3" 3" Height	LED-PNL-2X2-FLNG LED-PNL-2X4-FLNG	BPL-2X2-TRIM-BL 2x2 Black Trim
S-AUD-PIR-BT PIR ENVISIONLS Bluetooth Control	SK-20FT-Y-LC-CB 20' Suspension Kit	2X4-SM-3" 3" Height	LED-PNL-1X4-FLNG	BPL-2X4-TRIM-BL 2x4 Black Trim
S-AUD-PIR-SL PIR SILVAIR Bluetooth Mesh	CK-6FT-V 6' Chain Hanging Kit	1X4-SM-3" 3" Height		BPL-1X4-TRIM-BL 1x4 Black Trim

1. Custom height options available. Contact us.

Specs and model numbers are subject to change with or without notice. Customization of product is available.

FEATURES

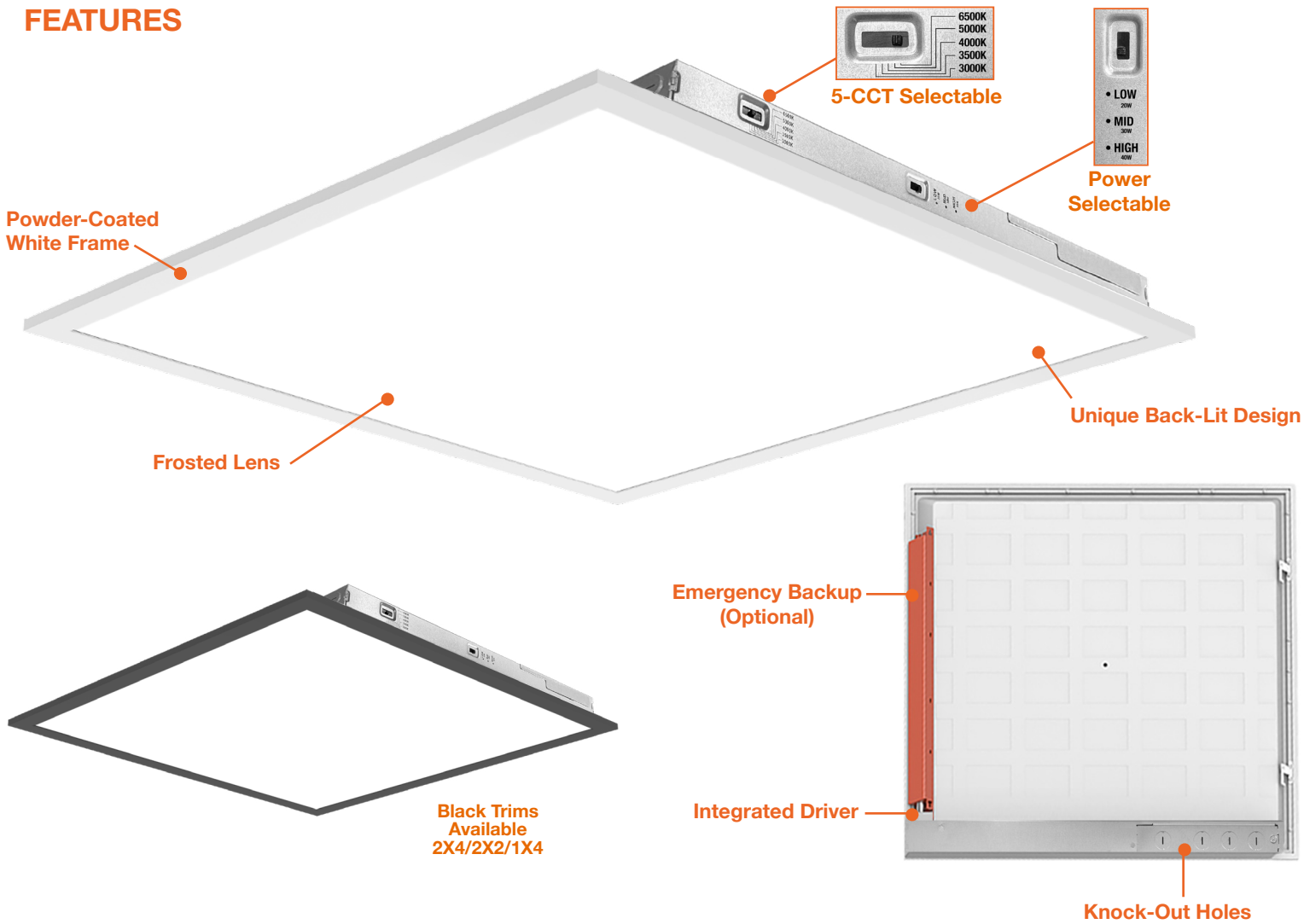

DIMENSIONS

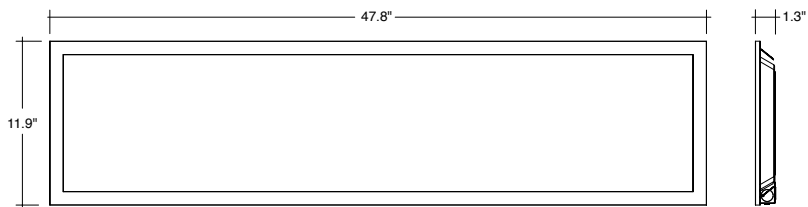

1X4

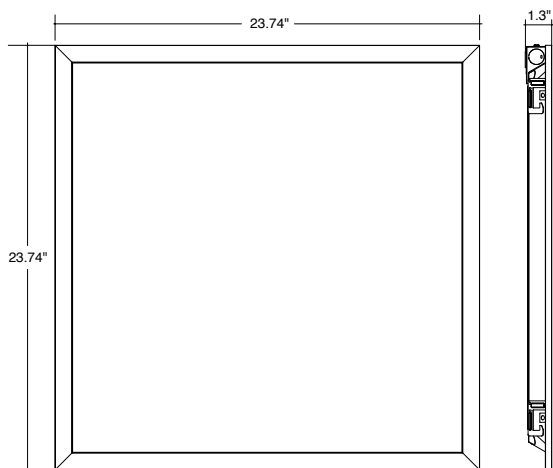

2X2

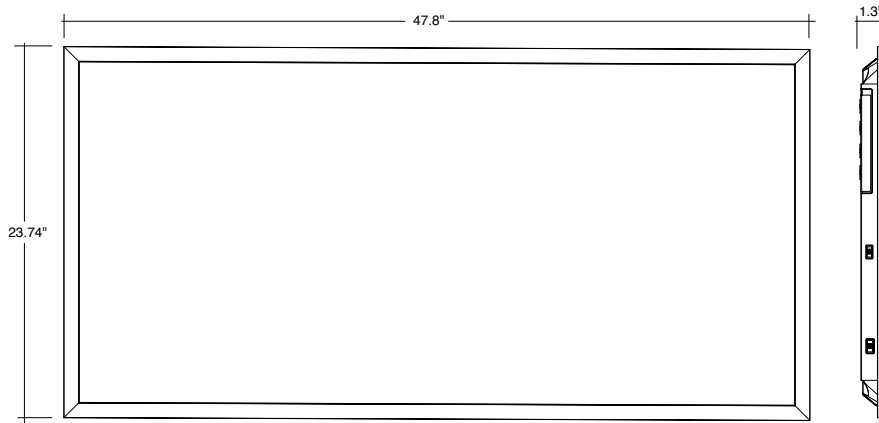

2X4

ACCESSORIES



SK-10FT-Y-LC-CB
SK-20FT-Y-LC-CB



CK-6FT-V



S-AUD-PIR-1
S-AUD-PIR-BT
S-AUD-PIR-SL

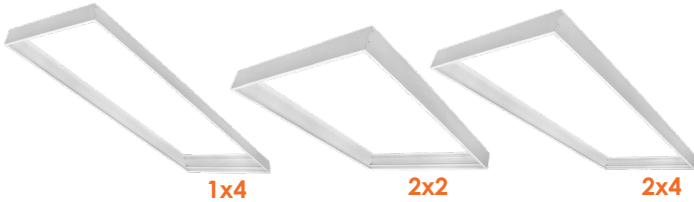

1x4

2x2

2x4

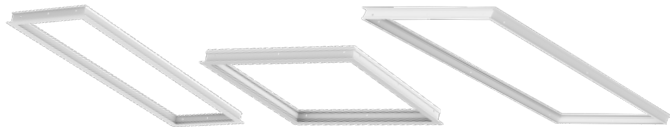

1x4

2x2

2x4



2x2



1x4



2x4

Model	Voltage	Watts	Lumens	Color	CRI
LED-BPL-2X2-3M40-5CCT	120/277V	20/30/40w	2600/3900/4400	30/35/40/50/65k	>80
LED-BPL-2X2-3M50-5CCT-HL	120/277V	30/40/50w	3900/4400/5500	30/35/40/50/65k	>80
LED-BPL-2X4-3M50-5CCT	120/277V	30/40/50w	3900/4400/5500	30/35/40/50/65k	>80
LED-BPL-2X4-3M65-5CCT-HL	120/277V	45/55/65w	5625/6875/8125	30/35/40/50/65k	>80
LED-BPL-1X4-3M40-5CCT	120/277V	20/30/40w	2600/3900/4400	30/35/40/50/65k	>80

SUSPENSION KITS

Accessory	Description
SK-10FT-Y-LC-CB	10' Suspension Kit
SK-20FT-Y-LC-CB	20' Chain Hanging Kit
CK-6FT-V	6' Chain Hanging Kit
LED-PNL-2X4-SK	3.5' Suspension Kit, works for all sizes

SENSORS

Accessory Model	Description
S-AUD-PIR-1	PIR Bi-Level Motion + Daylight Sensor Remote Required: (S-LINE-R)
S-AUD-PIR-BT	PIR ENVISIONLS Bluetooth Control
S-AUD-PIR-SL	PIR SILVAIR Bluetooth Mesh

SURFACE MOUNT KITS

Accessory	Description
2X2-SM-3"	2X2 Surface Mount Kit 3" Height for all Panels and Troffers
2X4-SM-3"	2X4 Surface Mount Kit 3" Height for all Panels and Troffers
1x4-SM-3"	1X4 Surface Mount Kit 3" Height for all Panels and Troffers

DRYWALL KITS

Accessory	Description
LED-PNL-2X2-FLNG	Flange (Drywall) Kit for Panels for all 2X2 Fixtures
LED-PNL-2X4-FLNG	Flange (Drywall) Kit for Panels for all 2X4 Fixtures
LED-PNL-1X4-FLNG	Flange (Drywall) Kit for Panels for all 1X4 Fixtures

TRIMS









Accessory	Description
BPL-2X2-TRIM-BL	2x2 LED Panel: Backlit-Line Black Trim
BPL-1X4-TRIM-BL	1x4 LED Panel: Backlit-Line Black Trim
BPL-2X4-TRIM-BL	2x4 LED Panel: Backlit-Line Black Trim

Luminaires for Ambient Lighting of - DLC Product ID:

LED-BPL-2x2-3M40-5CCT	S-IMBE52 (Standard)
LED-BPL-2x4-3M50-5CC	S-U0267J (Standard)
LED-BPL-1x4-3M40-5CCT	S-DR8V2E (Standard)
LED-BPL-2x2-3M50-5CCT-HL	S-V26054 (Standard)
LED-BPL-2x4-3M65-5CCT-HL	S-WNV8KG (Premium)

EnVisionLED™ Control Options

EnVision LED offers 3 control systems compatible with our LED Fixtures for projects of all sizes and budgets.

	Basic Controls	EnVisionLS 	EnVisionLED™ x SILVAIR 
Description	Standard Plug In Sensors	Basic Bluetooth Wireless Control	Advanced Bluetooth Wireless Control
Recommended Quantity (but not limited to)	N/A	>40-50 Nodes	>50 Nodes
Maximum Zone Quantity	N/A	100	3,000
Commissioning Tool	Remote Only	  ENVISIONLS App 	  SILVAIR App 
Commissioning Process	Individually Set via Remote	Wireless Must be done on site	Wireless- Initial linking must be done on site. Commissioning can be done via desktop remotely.
Floor Plan Upload	N/A	N/A	Yes Add a floor plan and mark luminaires & zones via desktop
Gateway	N/A	N/A	Required only for energy monitoring, advanced scheduling, automated demand response.
Individual Luminaire Control	Yes	Yes	Yes
Luminaire Grouping Zoning	N/A	Yes	Yes
High End Power Low End Power	Yes but limited (View Remote)	Yes	Yes
Cost	\$	\$\$	\$\$\$
DLC NLC Listed	N/A	Yes	Yes
Energy Monitoring & Data Reporting	N/A	N/A	Monitor energy usage per individual zone & retrofit cost savings calculation + detailed reporting



Compatible Products:

EnVision offers a variety of nodes, sensors, & gateways that are controlled via remote, ENVISIONLS Bluetooth Mesh & SILVAIR Bluetooth Mesh on all of our 0-10V dimmable fixtures.



Individual Fixture Controls: PIR Sensor, Bi-Level Dimming, Daylight

Basic Note: **-1** • ENVISIONLS Models Note: **-BT** • SILVAIR Models Note: **-SL**

	MODEL #	DESIGN	RECOMMENDED FIXTURE	FEATURES
	S-TWC-PIR-1 S-TWC-PIR-BT S-TWC-PIR-SL	Twist-C Control Sensor	Sensor Ready Fixtures: Area Lights, Canopies, Flood Lights, High Bays	All models are equipped with PIR occupancy sensing, high & low end bi-level dimming, & daylight sensing.
	S-TWC-90 + S-TWC-PIR-1 S-TWC-90 + S-TWC-PIR-BT S-TWC-90 + S-TWC-PIR-SL	Twist-C Control Sensor + 90 Degree Arm	Cylinders, Strips, Wall Packs	
	S-AUD-PIR-1 S-AUD-PIR-BT S-AUD-PIR-SL	2.5m Audio Jack	Panels & Troffers	
	S-SN-PIR-1 S-SN-PIR-BT S-SN-PIR-SL	Snap In Sensor	Troffers & Wraps	

Group Controls ENVISIONLS Models Note : **-BT** • SILVAIR Models Note: **-SL**

	MODEL #	DESIGN	VOLTAGE	FEATURES	RECOMMENDED FEATURES
	S-CM-PIR-LV-BT S-CM-PIR-LV-SL	Ceiling Mounted PIR Sensor	12-24V	PIR Sensor, Bi-Level Dimming, Daylight, 360° detection, 12' Max Mounting Height	Connects to 0-10V dimmable fixtures
	S-WM-PIR-CUNV-BT S-WM-PIR-CUNV-SL	Wall Mounted PIR Occupancy Sensor, Bi-Level Dimming, Daylight	120-277V	On/Off PIR occupancy sensor, 180° detection, 30' detection @ 4' Mounting Height	Connects to LED fixtures
	S-WS-120V-USB-SL		120V	Dimming Wall Socket, Two Sockets	Floor Lamps, Other Lamps

Gateway (Silvair Only) 4.5–5.5 V DC, 2A Power over Ethernet 36–57 V DC

	MODEL #	DESIGN	VOLTAGE	FEATURES	RECOMMENDED FEATURES
	SGW-102	Wall or Ceiling Mounted	POE	Advanced Energy Monitoring Control	Connects to Silvair Controls. Gateway is not required.