

TE612LED, 2-LIGHT TRIMLESS LED MULTIPLE RECESS

PRODUCT DETAILS

No.	:	TE612LED-30-4-01
Product Color	:	BLACK
Length	:	8.25"
Width	:	4"
Height	:	5"

LIGHT SOURCE DETAILS

Light Source Type	:	INTEGRATED LED
Input Voltage	:	120V
Bulb Voltage	:	120V
Socket Type	:	LED
Total Wattage	:	30W
Total Lumen	:	2580lm
Kelvin	:	3000K
CRI	:	90
Dimmable	:	Yes



Options Available

ITEM NO.	FINISH	SHADE
TE612LED-30-4-01	BLACK	
TE612LED-30-4-02	WHITE	

TECHNICAL DETAILS

Driver	:	ES 16.8W Current Driver
Location	:	DRY
Approval	:	
Beam Angle	:	40
Cut Hole Length	:	8.563"
Cut Hole Width	:	4.188"

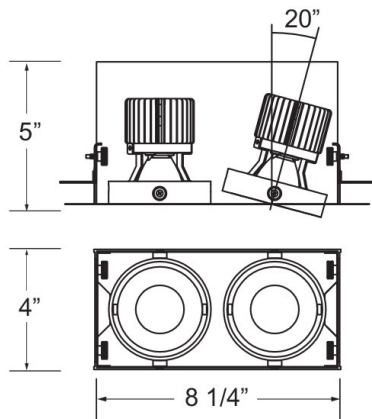

PROJECT INFORMATION

 Job Name: Date: Type:

 Comments: