

Project Name:	Type:
Part Number:	Date:

THINFIT 6" COMMERCIAL DOWNLIGHT

SPECIFICATION FEATURES

- **Mechanical** - Shallow die cast aluminum heat sink with a low profile external driver is ideal for new or remodel construction. Two rugged spring clips allow for both easy installation and field accessibility below the ceiling.
- **Electrical** - Externally mounted driver, 120 - 277V voltage, 50/60Hz, 0 - 10V dimming to 10%. Quick connect electrical connect in metal clad cable. Go to www.greencreative.com for complete dimmer compatibility list.
- **Optical** - Edge lighting technology featuring a PMMA light guide plate and smooth polycarbonate lens ensures an even light emitting surface. Available in 3000K, 3500K and 4000K with a minimum of 90 CRI.
- **Thermal** - Die cast aluminum heat sink with its edge lighting design maximizes thermal dissipation. L70 rated lifetime of 50,000 hours. Fixture operating temperature: -4°F to 95°F (-25°C to 35°C)
- **Compliance and warranty** - ETL Classified and Listed for wet location. Certified air-tight per ASTM 283-04, IC rated for direct contact with insulation. 5 year parts warranty for complete fixture.



060623



BENEFITS

- Quick and easy installation with spring action clip
- External driver with quick connector for easy wiring
- Suitable for shallow ceiling applications
- Install almost everywhere with Wet Location, IC and Air-tight ratings
- Edge lighting technology for gentle and smooth diffusion

APPLICATIONS

- Commercial
- Residential
- Educational
- Hospitality
- Retail

ORDERING INFORMATION

Series	Size	CRI	CCT	Driver
<input checked="" type="checkbox"/> 12NCDL New Construction Downlight 12W	<input checked="" type="checkbox"/> R6DIM 6"	<input checked="" type="checkbox"/> 9 CRI 90	<input type="checkbox"/> 30 3000K <input type="checkbox"/> 35 3500K <input type="checkbox"/> 40 4000K	<input checked="" type="checkbox"/> 277V / EXT 120 - 277V, 0-10V Dimmable to 10%

LINE DRAWINGS

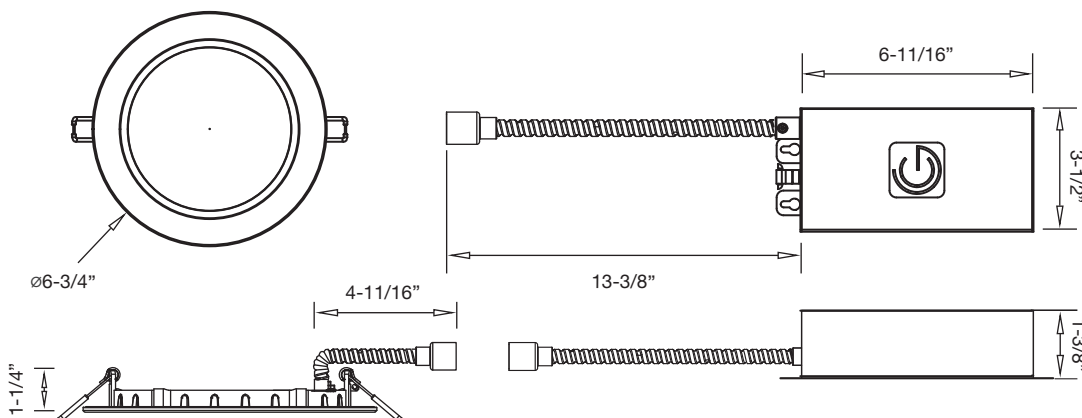

Ceiling Cutout	
Minimum	Maximum
$\varnothing 5-15/16"$	$\varnothing 6-5/16"$



THINFIT 6" COMMERCIAL DOWNLIGHT

TECHNICAL INFORMATION

Dimming	Input Voltage	Input Frequency	Input Current	Input Power	THD Power	Power Factor
0-10V	120-277V	50 / 60Hz	0.10A	12W	<20%	>0.9

PHOTOMETRY

12NCDLR6DIM/935/277V/EXT

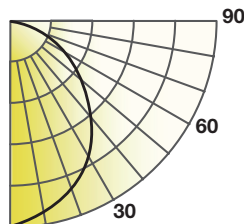

Lumens: 1056 lm
 Power: 12 W
 Efficacy: 91 lm/W
 CRI: 90+
 Spacing Criteria: 1.25
 Beam Angle: 100°

Candlepower Distribution	
Angle (°)	Average (cd)
0	364
5	362
15	350
25	324
35	289
45	243
55	192
65	136
75	77
85	20
90	0

Initial Footcandles		
Height (ft)	Fc	Diameter (ft)
8	6	24
9	4	27
10	4	30
12	3	37
15	2	46

Zonal Lumen Summary		
Zone	Lumens	%Fixture
0-30	282	27
0-40	463	44
0-60	821	78
0-90	1056	100

Coefficient		
3000K	3500K	4000K
0.96	1.00	1.01

PERFORMANCE











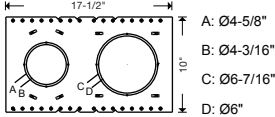
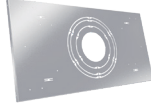
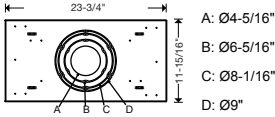

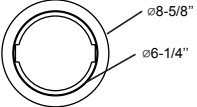

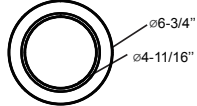
12NCDLR6DIM/9xx/277V/EXT

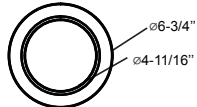
CCT	3000K	3500K	4000K
Lumens	1017	1056	1069
LPW	88	91	93

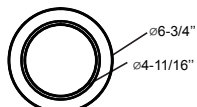
ORDERING GUIDE

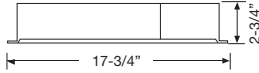
Product	Model
98217	12NCDLR6DIM/930/277V/EXT
98218	12NCDLR6DIM/935/277V/EXT
98219	12NCDLR6DIM/940/277V/EXT

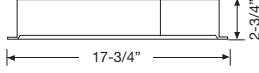
THINFIT 6" COMMERCIAL DOWNLIGHT

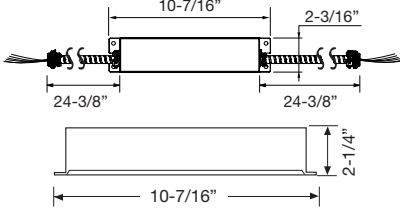
ACCESSORY ORDERING INFORMATION				
Product	Model	Description	Pictures	Dimenions
98280	NCDL46RPLATE	4" & 6" THINFIT EXT Series New Construction Plate for Stud/Joist Mounting		 A: Ø4-5/8" B: Ø4-3/16" C: Ø6-7/16" D: Ø6"
98501	NCPLATE/T4689	New Construction or Remodel Plate for T-Grid Ceilings		 A: Ø4-5/16" B: Ø6-5/16" C: Ø8-1/16" D: Ø9"
97848	DLNC6GOOF/R	6" THINFIT EXT Series GOOF RING		 Ø8-5/8" Ø6-1/4"
98348	NCDLR6TRIMBL	6" THINFIT EXT Series Black Trim		 Ø6-3/4" Ø4-11/16"
98349	NCDLR6TRIMBN	6" THINFIT EXT Series Brushed Nickel Trim		 Ø6-3/4" Ø4-11/16"
98350	NCDLR6TRIMBZ	6" THINFIT EXT Series Bronze Trim		 Ø6-3/4" Ø4-11/16"
58012	35EMINVERTER	35W Emergency Inverter (Field Installation)		 17-3/4" 2-3/4"
58013	35EMINVERTER/CEC	California Title 20 Compliant 35W Emergency Inverter (Field Installation)		 17-3/4" 2-3/4"
98003	23EMDRIVER	California Title 20 Compliant 23W Emergency LED Driver (Field Installation)		 10-7/16" 2-3/16" 24-3/8" 24-3/8" 2-1/4" 10-7/16"

Note: All rights reserved. All sizes and specifications are subject to change at any time without notice.