

Project Name:

Part Number:

Type:

AREA LIGHT SERIES

OUTDOOR

FEATURES

- Slim Profile die-cast aluminum housing
- Factory Select Finishes: Bronze (BRZ), Black (BLK), Silver (SLV) & White (WHT)
- Custom colors finishes available
- Type II, III, IV, & VS optics available
- Optional Spill Light Control via Integral Shield (HSS)
- UPMB - Universal Pole Mounting Bracket (std.)
- 1.5G/3G ANSI C136.31-2010 mounting option available
- Toolless hinged drop down driver access
- 120-277V Universal Voltage or 347-480V High Voltage
- 0-10V Dimmable Driver (std.)
- Battery backup option available (56W, 90W)
- PIR Occupancy, Photocell, & Bi-Level Dimming Sensors Available
- 3-Pin & 7-Pin ANSI C136.41 Control Receptacle Options
- Wireless control integrated luminaire
- 3000K, 4000K & 5000K CCT
- >70 Color Rendering Index (CRI)
- Calculated L70 >100,000 hrs @ 25°C per TM-21-11
- IP66 Rated Luminaire
- Dark Sky Compliant^{1,2}
- 5 Year Warranty; 10 Year Optional Warranty
- ETL Listed for Wet Locations
- DesignLights Consortium® Premium Qualified Luminaire

¹ 3000K is IDA Listed

² Must select UPMB, ARM6, WMB, or HTMA mounting options to qualify



407-478-3759
www.ilp-inc.com

SUITABLE APPLICATIONS

- Parking Structures
- Roadways
- Parks
- Education
- Hospitals
- Car Dealerships
- Roadways
- Shopping Centers

ORDERING GUIDE:

SERIES	WATTS	DRIVER	CCT	OPTIC	MOUNTING	FINISH ⁶	WARRANTY
AL	56W	U 120-277V	50	T2	UPMB	BLANK	5 Year
Area Light	90W	HV ² 347-480V	40	T3	UPMB/R	BLK	10YR ^{14,15} 10 Year
	110W		30	T4	ARM6-S	SLV	
	150W			T5S	ARM6-Rx ³	WHT	
	190W				AL-SLFP	CC	
	225W				AL-SB ⁴		
	270W				HTMA		
	375W				WMB ⁴		
					LARGE-WMB ⁵		

OPTIONS		CONTROLS	
Factory Installed		BASIC - Factory Installed	
HSS ¹	Integral House Side Shield	CR3P	Universal 3-Pin control receptacle
SP1 ^{7,8}	10KA Max Univolt Surge Protector	CR7P ¹³	Universal 7-Pin control receptacle ANSI C136.41
SP2 ^{7,8}	22KA Max Univolt Surge Protector	USBD ¹¹	Bluetooth User Select Bi-Level Dim Occ. Sensor
SP480V2 ⁷	20KA Max 347-480V Surge Protector	BDDX ¹²	Preset Bi-Level Dim Sensor (xx=% ex: 20,30)
FI/ILBCP05 ⁹	5W LED Factory Installed Battery Backup	BDDXPC ¹²	Preset Bi-Level Dim Sensor w/ photocell (xx=% ex: 20,30)
FUSE/SXXX	Single-line Voltage Fuse (120, 277 or 347V)	WLOS	PIR Occupancy Sensor
FUSE/DXXX	Dual-line Voltage Fuse (208, 240 or 480V)		
SMLxxxx	Specified Lumen Output (xxxx = lumen output)		
SD347 ^{1,4,8}	347V Step Down Transformer		
SD480 ^{1,4,8}	480V Step Down Transformer		
TPS/L	Tamperproof Fixture Latches		
TPS/FF	Tamperproof Screws Full Fixture		
Ship with Accessories		ADVANCED - Factory Installed	
GS ¹	External Glare Shield	SU/5S/LR/IL ^{2,8}	Enlighted 5S Individual Lighting (IL) Sensor with Control Unit
SRP/281	IR-TEC OS-NET Remote Sensor Configuration Tool	SU/5S/LR/CL ^{2,8}	Enlighted 5S Connected Lighting (CL) Sensor with Control Unit
TLPC/UNIV	Photocell for use w/ CRxP option (120-277V)	SU/5S/LR/IOT ^{2,8}	Enlighted 5S Internet of Things (IOT) Sensor with Control Unit
TLPC/HV	Photocell for use w/ CRxP option (347V-480V)	LPL/INT ^{1,2,8}	Limelight by Lutron Wireless Control System w/ Sensor (8-15ft)
		LPM/INT ^{1,2,8}	Limelight by Lutron Wireless Control System w/ Sensor (15-30ft)
		LPH/INT ^{1,2,8}	Limelight by Lutron Wireless Control System w/ Sensor (30-40ft)
		IRTEC/W/B ^{1,2,7,12}	IR-TEC OS-NET Wireless Control System w/ Sensor
Ship with Accessories		Ship with Accessories	
		PCU ⁸	Electronic UNIV Photocell (120-277V)

¹ Does not qualify for DLC

² Not available with SD347 or SD480 options

³ Must specify pole diameter (3"-6")

⁴ EXCLUDES 270W-375W

⁵ 270W-375W ONLY

⁶ Bronze, Black, Silver & White finishes are standard. Consult factory for pricing & availability of other finishes; subject to longer lead times

⁷ SP1/SP2 specified in combination w/ battery backups, separate surge protectors are required per electrical line

⁸ Not available with HV option

⁹ 56W-90W ONLY

¹¹ Requires bluetooth enabled device for programming (provided by others)

¹² Requires SRP/281 to program

¹³ Dimming leads will be wired to receptacle unless otherwise specified

¹⁴ Requires additional surge protection (SP1, SP2, SP480V2); For additional details see general terms and conditions

¹⁵ Contact Factory for more details

AREA LIGHT SERIES

OUTDOOR

LED SYSTEMS INFO ¹		3000K			4000K			5000K			Watts ²	DLC Listing	Replaces
Part Numbers	Optic	Lumens	Efficacy	BUG Rating	Lumens	Efficacy	BUG Rating	Lumens	Efficacy	BUG Rating			
AL-56W	T2	7,780 lm	133 lm/W	B2-U0-G2	8,484 lm	147 lm/W	B2-U0-G2	8,558 lm	149 lm/W	B2-U0-G2	58 W	Premium	250W MH
	T3	7,576 lm	130 lm/W	B2-U0-G2	8,457 lm	147 lm/W	B2-U0-G2	8,531 lm	148 lm/W	B2-U0-G2			
	T4	7,515 lm	129 lm/W	B2-U0-G2	8,217 lm	143 lm/W	B2-U0-G2	8,289 lm	144 lm/W	B2-U0-G2			
	T5S	7,707 lm	132 lm/W	B3-U0-G2	8,430 lm	146lm/W	B2-U0-G2	8,505 lm	148 lm/W	B3-U0-G2			
AL-90W	T2	12,137 lm	130 lm/W	B3-U0-G3	12,782 lm	135 lm/W	B3-U0-G3	12,894 lm	137 lm/W	B3-U0-G3	94 W	Premium	250W MH
	T3	11,784 lm	126 lm/W	B3-U0-G3	12,741 lm	135 lm/W	B3-U0-G3	12,853 lm	136 lm/W	B3-U0-G3			
	T4	11,689 lm	125 lm/W	B2-U0-G2	12,380 lm	131 lm/W	B2-U0-G2	12,489 lm	132 lm/W	B2-U0-G2			
	T5S	12,024 lm	128 lm/W	B4-U0-G2	12,702 lm	135 lm/W	B4-U0-G2	12,813 lm	136 lm/W	B4-U0-G2			
AL-110W	T2	16,640 lm	147 lm/W	B3-U0-G3	17,584 lm	156 lm/W	B3-U0-G3	17,739 lm	158 lm/W	B3-U0-G3	113 W	Premium	400W MH
	T3	16,205 lm	143 lm/W	B3-U0-G3	17,528 lm	156 lm/W	B3-U0-G3	17,682 lm	157 lm/W	B3-U0-G3			
	T4	16,074 lm	142 lm/W	B3-U0-G3	17,031 lm	151 lm/W	B3-U0-G3	17,181 lm	153 lm/W	B3-U0-G3			
	T5S	16,485 lm	145 lm/W	B4-U0-G2	17,473 lm	155 lm/W	B4-U0-G2	17,627 lm	157 lm/W	B4-U0-G2			
AL-150W	T2	19,533 lm	133 lm/W	B3-U0-G3	21,671 lm	146 lm/W	B3-U0-G3	21,861 lm	147 lm/W	B3-U0-G3	149 W	Premium	400W MH
	T3	19,022 lm	130 lm/W	B3-U0-G3	21,601 lm	145 lm/W	B3-U0-G3	21,601 lm	145 lm/W	B3-U0-G3			
	T4	18,869 lm	129 lm/W	B3-U0-G3	20,989 lm	141 lm/W	B3-U0-G3	21,173 lm	142 lm/W	B3-U0-G3			
	T5S	19351 lm	132 lm/W	B4-U0-G2	21,534 lm	145 lm/W	B4-U0-G2	21,723 lm	146 lm/W	B4-U0-G2			
AL-190W	T2	24,185 lm	128 lm/W	B4-U0-G4	26,664 lm	142 lm/W	B4-U0-G4	26,898 lm	143 lm/W	B4-U0-G4	188 W	Premium	600W MH
	T3	23,552 lm	125 lm/W	B3-U0-G3	26,579 lm	142 lm/W	B3-U0-G3	26,812 lm	143 lm/W	B3-U0-G3			
	T4	23,362 lm	124 lm/W	B3-U0-G4	25,825 lm	137 lm/W	B3-U0-G4	26,052 lm	139 lm/W	B3-U0-G4			
	T5S	23,959 lm	127 lm/W	B5-U0-G3	26,496 lm	141 lm/W	B5-U0-G3	26,729 lm	142 lm/W	B5-U0-G3			
AL-225W	T2	28,370 lm	124 lm/W	B4-U0-G4	30,326 lm	131 lm/W	B4-U0-G4	30,592 lm	135 lm/W	B4-U0-G4	232 W	Premium	600W MH
	T3	27,688 lm	120 lm/W	B3-U0-G4	30,229 lm	131 lm/W	B3-U0-G4	30,495 lm	135 lm/W	B3-U0-G4			
	T4	27,405 lm	119 lm/W	B3-U0-G4	29,372 lm	127 lm/W	B3-U0-G4	29,630 lm	131 lm/W	B3-U0-G4			
	T5S	28,166 lm	122 lm/W	B5-U0-G3	30,135 lm	130 lm/W	B5-U0-G3	30,400 lm	134 lm/W	B5-U0-G3			
AL-270W	T2	37,589 lm	139 lm/W	B4-U0-G4	40,094 lm	149 lm/W	B4-U0-G4	40,446 lm	150 lm/W	B4-U0-G4	270 W	Premium	1000W MH
	T3	36,605 lm	136 lm/W	B4-U0-G4	39,966 lm	148 lm/W	B4-U0-G4	40,317 lm	150 lm/W	B4-U0-G4			
	T4	36,310 lm	135 lm/W	B4-U0-G5	38,833 lm	144 lm/W	B4-U0-G5	38,655 lm	147 lm/W	B4-U0-G5			
	T5S	37,238 lm	138 lm/W	B5-U0-G5	39,842 lm	148 lm/W	B5-U0-G5	39,630 lm	150 lm/W	B5-U0-G5			
AL-375W	T2	48,914 lm	128 lm/W	B5-U0-G5	52,323 lm	137 lm/W	B5-U0-G5	52,783 lm	138 lm/W	B5-U0-G5	383 W	Premium	1000W MH
	T3	47,634 lm	125 lm/W	B4-U0-G5	52,156 lm	136 lm/W	B4-U0-G5	52,614 lm	137 lm/W	B4-U0-G5			
	T4	47,250 lm	124 lm/W	B4-U0-G5	50,677 lm	132 lm/W	B4-U0-G5	51,122 lm	134 lm/W	B4-U0-G5			
	T5S	48,457 lm	127 lm/W	B5-U0-G4	51,993 lm	136 lm/W	B5-U0-G4	52,450 lm	137 lm/W	B5-U0-G4			

¹Values are nominal, see IES file for more detail

²Electrical data at 25C (77F). Actual wattage may differ by +/-10%.

EPA RATINGS

	ARM6-S	UPMB	HTMA	AL-SLPF	AL-SB
SMALL: AL-56W & 90W	0.61 ft ²	0.76 ft ²	0.58 ft ²	0.71 ft ²	0.60 ft ²
MEDIUM: AL-110W, 150W, 190W, & 225W	0.77 ft ²	0.92 ft ²	0.73 ft ²	0.84 ft ²	0.76 ft ²
LARGE: AL-270W & 375W	1.03 ft ²	1.17 ft ²	0.98 ft ²	1.10 ft ²	NA

WEIGHT
17lb
23lb - 26lb
40lb

* EPA Ratings listed assume fixture is mounted horizontally. For adjustable mounting options, EPA will vary with selected angle.

AREA LIGHT SERIES

OUTDOOR

SPECIFICATIONS

CONSTRUCTION

The AL series features a slim profile die-cast aluminum housing available in 3 different sizes for a fully scalable solution. The versatile 8 optional mounting methods allows for easy installation while the toolless swappable hinged door allows for quick drop down driver access for maintenance. The fully gasketed housing is IP66 rated for whole luminaire ingress protection. The AL Series is protected with a durable bronze polyester powder coat finish to withstand extreme weather changes without cracking or peeling. Alternate standard or custom finishes are wet painted over the bronze powdercoat.

ELECTRICAL

High-performance driver features over-voltage, under-voltage, short circuit and over temperature protection. 0-10V dimming (10% - 100%) standard. Standard Universal Voltage (120-277 Vac) Input 50/60 Hz or optional High Voltage (347-480 Vac). L70 >100,000 hrs. in accordance of IESNA TM-21-11 projected values at 25°C Ambient temperature. Total harmonic distortion: <20%. Power factor: >0.90. Input power stays constant over life. Minimum 6kV surge rating meets a minimum Category C Low operation (per ANSI/IEEE C62.41.2). Additional protection is available in 10kV and 20kV options. Optional 120-277V standard battery backups and CEC Title 20 compliant battery backups are available in the small size housing (56W-90W). The 90-minute batteries provide constant power to the LED system, ensuring code compliance and a test switch/indicator button is installed on the housing for ease of maintenance.

INSTALLATION

The versatile AL series comes with 8 optional mounting methods. The 1.5G rated quick mount standard UPMB or UPMB/R arm allows for pole mounting to any square or 4-5" round poles and is slotted to install onto any pole with a vertical mounting pattern between 2"-4 $\frac{1}{8}$ ". The 1.5G rated ARM6-S or ARM6-Rx allows for pole mounting to any square or 3"-6 $\frac{1}{2}$ " round poles. The 3G rated HTMA is designed for straight horizontal 2"(2 $\frac{3}{8}$ " OD) mast arms. The 1.5G rated Adjustable Slip fitter (AL-SLPPF) mounts to any vertical or horizontal tenon 2" pipe (2 $\frac{3}{8}$ " OD) allowing for tilting the AL up to 70° from horizontal plane. The trunnion bracket (AL-SB) enables the AL to be used for general flood applications and can tilt the AL series up to 70° from the horizontal plane (56W-225W only). The Wall mount bracket allows for easy installation to any vertical wall surface. All mounting methods are provided with a 3-wire 3' outdoor rated cord is provided for wiring. 5-wire cord optional for external dimming, consult factory.

WARRANTY

5 Year Warranty Standard; 10Y Year Warranty Optional ([Terms and Conditions apply](#)).

OPTICS

The IP66 silicone gasket sealed optical chamber utilizes proprietary polycarbonate refractive optics to provide exceptional coverage and uniformity in IES Types 2, 3, 4, & 5S. Available in 5000K, 4000K, and 3000K, color temperatures per ANSI C78.377. Minimum CRI of 70. The optical integrated House side shield (HSS) option allows for improved back-light control without any large shields taking away from the site. The AL series produces Zero uplight and is IDA listed in 3000K color temperature. Optional field installed 3-sided glare shield accessory is available for on-site external house side protection.

THERMAL

The AL Series features an array of High-efficacy LED's mounted on a metal core circuit board. The LED boards are mounted directly to the cast aluminum housing with heat dissipating fins to provide excellent thermal performance extending the life of electronic components. Operating Ambient Temperature: -40°C to +50°C (-40°F to 122°F). Operating temperature for standard and CEC Compliant battery backup: -0°C to +50°C (-32°F to +122°F).

CONTROLS

Standalone Controls: Two ½" NPT apertures allow for field installed 120-277V universal electronic pencil photocells. Factory installed 3-Pin & 7-Pin ANSI C136.41 Control Receptacle Options available. Twist lock photocells sold separately (See accessories). Optional PIR sensors available installed in housing hinged door. Sensors provide optional on/off control, photocell capability, bi-level dimming, and bluetooth configuration allows for on-site modifications.

Wireless Control Systems: The AL Series is wireless mesh controls ready with IR-TEC, Enlighted, and Lutron Limelight wireless control platforms. Available with and without PIR sensors. Inquire with factory for more information or for additional controls options, including customer supplied items.

CERTIFICATIONS

ETL Listed for wet locations. Tested in accordance with IESNA LM-79 and LM-80 standards. BAA compliant. RoHS Compliant. IDA compliant; with 3000K color temperature selection. Title 24 Compliant; see local ordinance for qualification information. IP66 rated Luminaire per IEC 60598. IP66 rated optical chamber. DesignLights Consortium® (DLC) Premium qualified product. Not all versions of this product may be DLC qualified. Please check the DLC Qualified Products List at www.designlights.org/QPL to confirm which versions are qualified.

AREA LIGHT SERIES

OUTDOOR

OPTIONS



HSS

Integral House Side Shield

Delivers backlight control that significantly reduces light spill behind the pole for applications with pole locations close to adjacent properties. Shown with Medium AL-110W - 225W



GS

External Glare Shield

3-sided field installable external glare shield. Shown with Medium AL-110W - 225W



UPMB (/R)

Square or 4-5" Round Universal Pole Mounting Bracket



WMB

Wall Mount Bracket (56W-225W)



LARGE-WMB

Large Wall Mount Bracket (270W-375W)

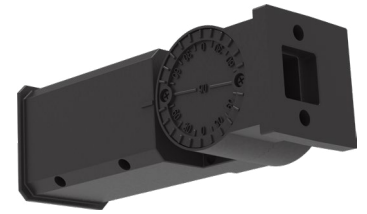

AL-SLPF

Adjustable Slip Fitter

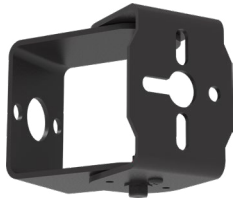

AL-SB

Swivel Bracket (56W-225W)



HTMA

Horizontal Tenon Mount Adaptor

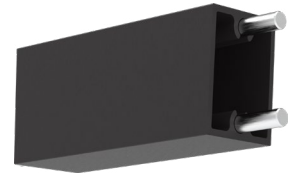

ARM6-S (Rx)

6" Straight Arm Adaptor for Square or Round Pole 3"-6", (must specify diameter)

ADDITIONAL FEATURES

TOOLLESS DRIVER ACCESS

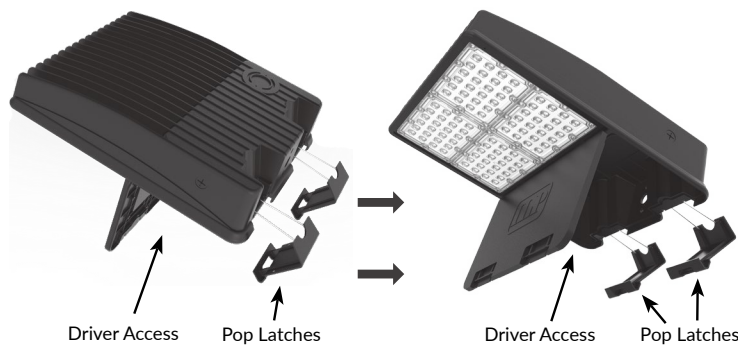

Shown with Medium AL-110W - 225W

AREA LIGHT SERIES

OUTDOOR

ADDITIONAL FEATURES CONT'D

FACTORY SELECT FINISH GUIDE

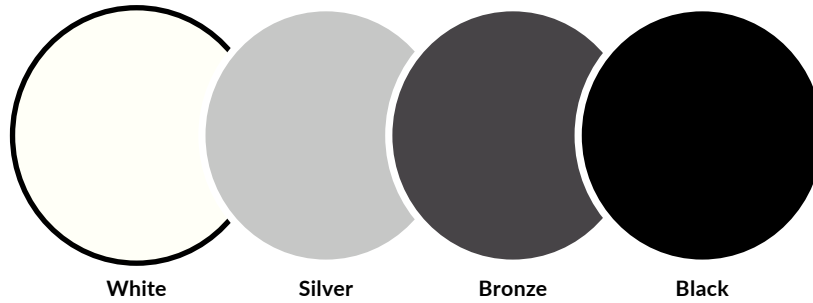

COLOR NAME AND DESCRIPTION		SHEEN	PRICING
WHT	- ILP White	SEMI GLOSS	Standard
SLV	- ILP Silver - Ultrasonic Chrome	GLOSS	Standard
BRZ	- ILP Bronze	SEMI GLOSS	Standard
BLK	- ILP Black	SEMI GLOSS	Standard

COLORS SHOWN ABOVE ARE TO BE USED AS REFERENCE, NOT EXACT MATCH. PLEASE REQUEST PAINT CHIPS FOR EXACT MATCH.

LINE DRAWINGS

SMALL: 56W-90W

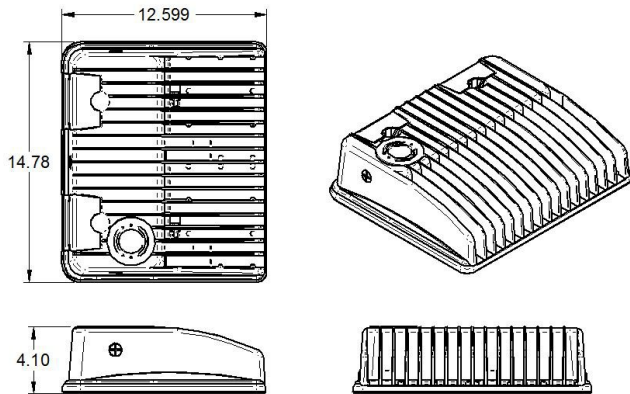

MEDIUM: 110W-225W

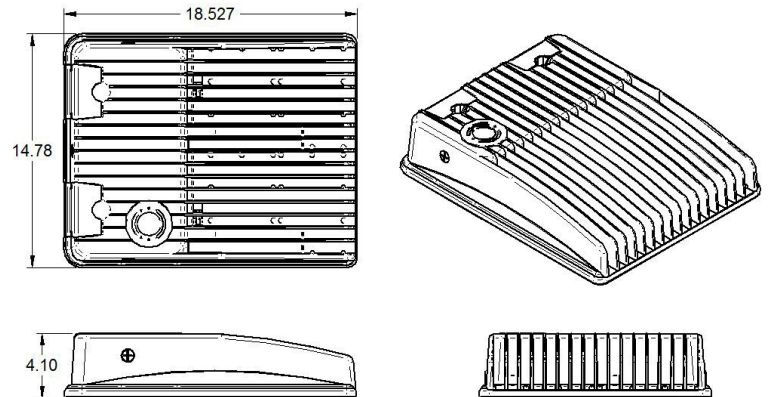

LARGE: 270W-375W

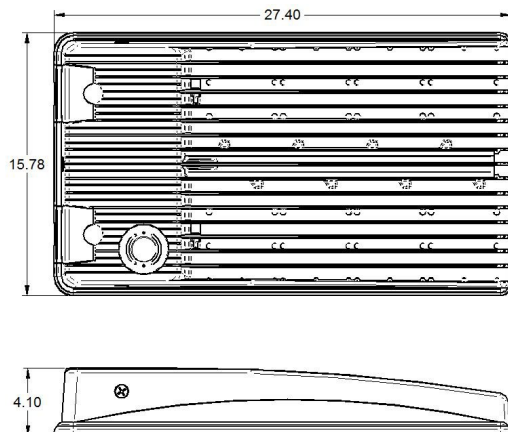

AREA LIGHT SERIES

OUTDOOR

PHOTOMETRIC REPORTS

Photometric values based upon tests performed in compliance with LM-79. IES files can be downloaded at www.ilp-inc.com
Blue = .5 fc, Orange = 1 fc, & Green = 2 fc

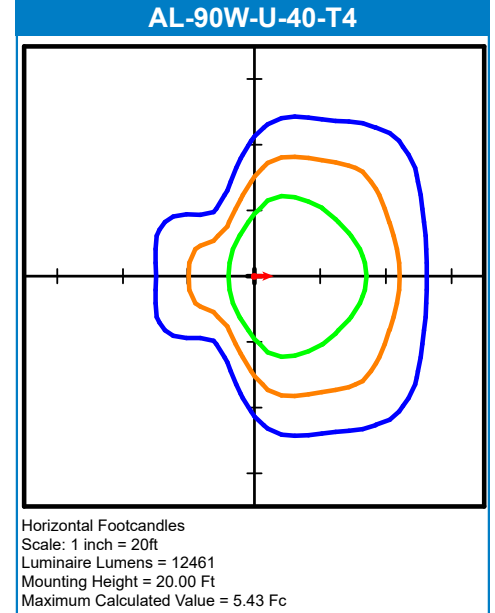
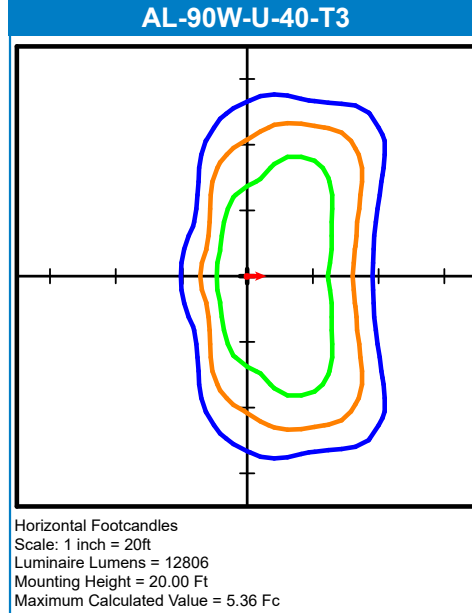
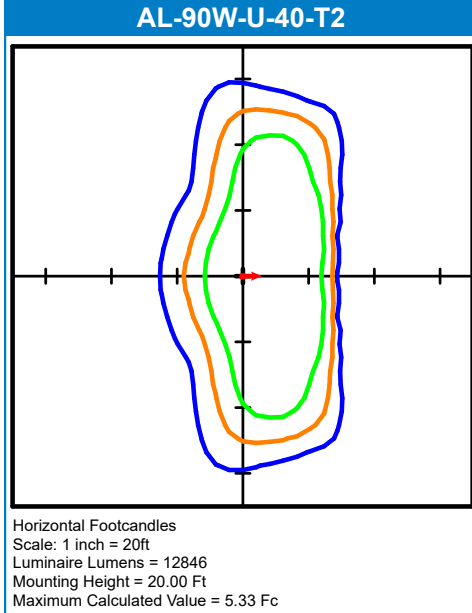
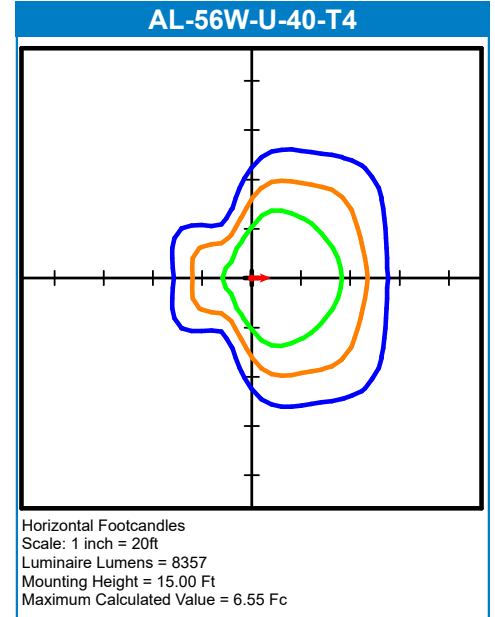
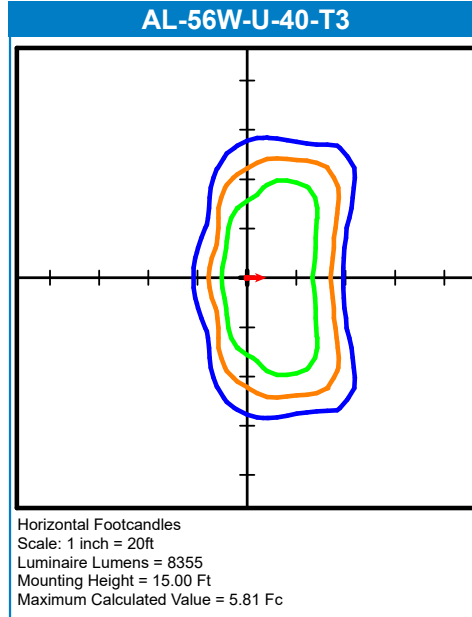
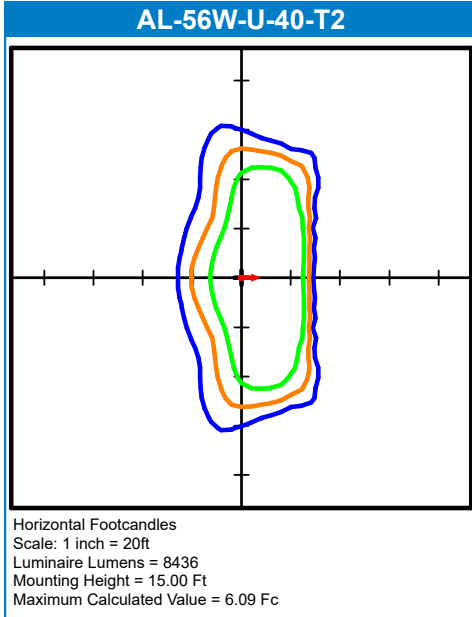

AREA LIGHT SERIES

OUTDOOR

PHOTOMETRIC REPORTS

Photometric values based upon tests performed in compliance with LM-79. IES files can be downloaded at www.ilp-inc.com
Blue = .5 fc, Orange = 1 fc, & Green = 2 fc

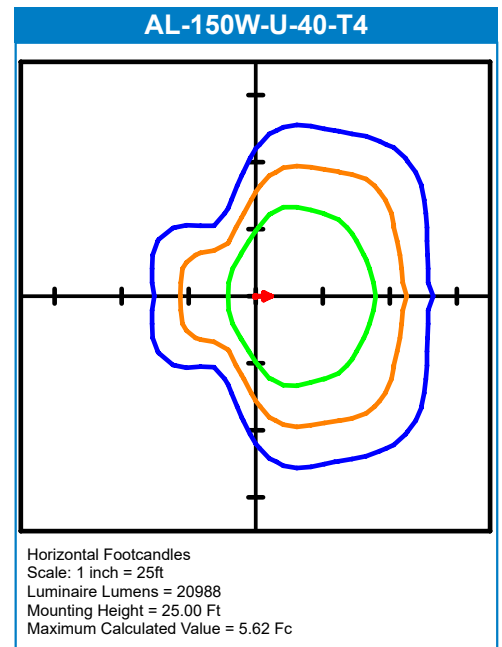
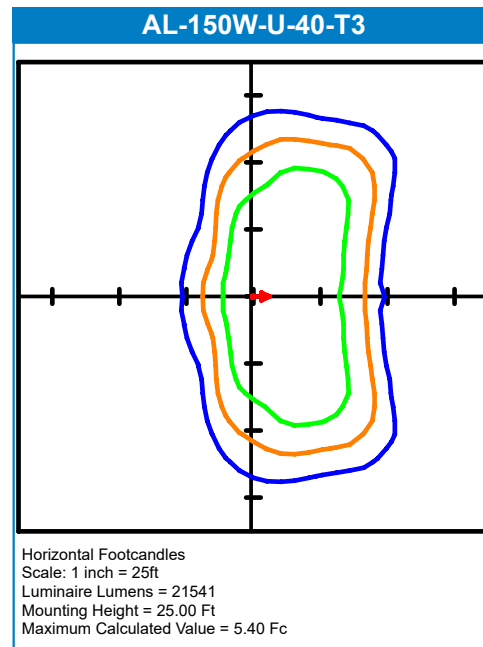
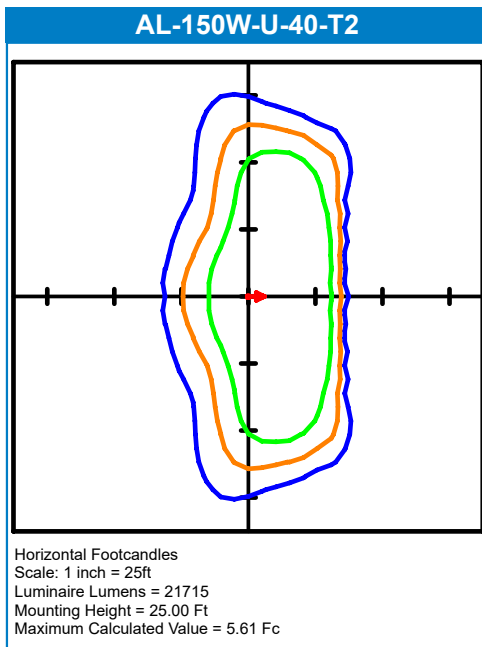
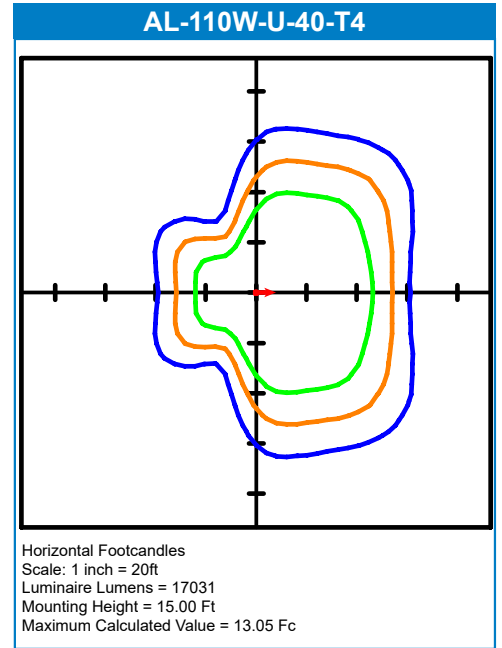
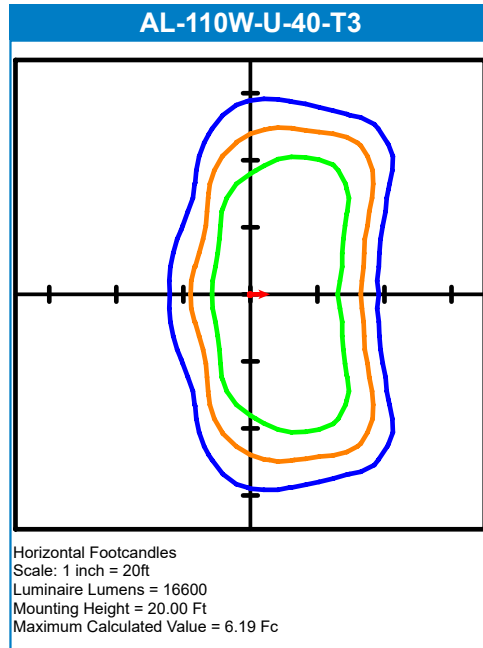
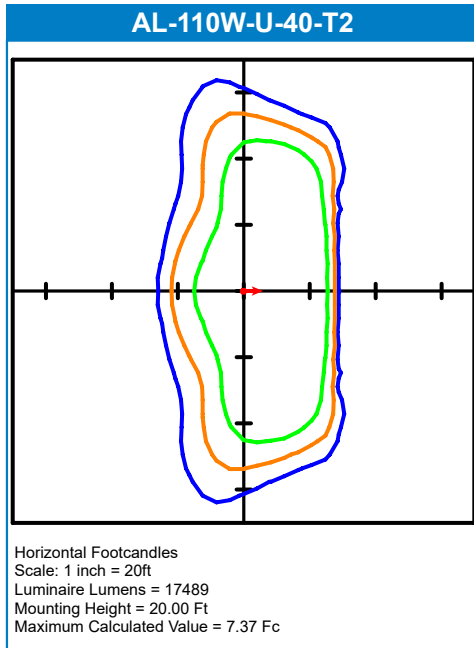

AREA LIGHT SERIES

OUTDOOR

PHOTOMETRIC REPORTS

Photometric values based upon tests performed in compliance with LM-79. IES files can be downloaded at www.ilp-inc.com
Blue = .5 fc, Orange = 1 fc, & Green = 2 fc

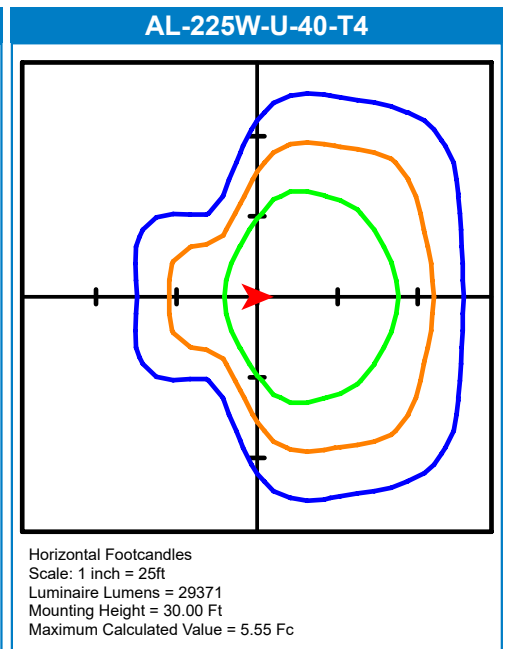
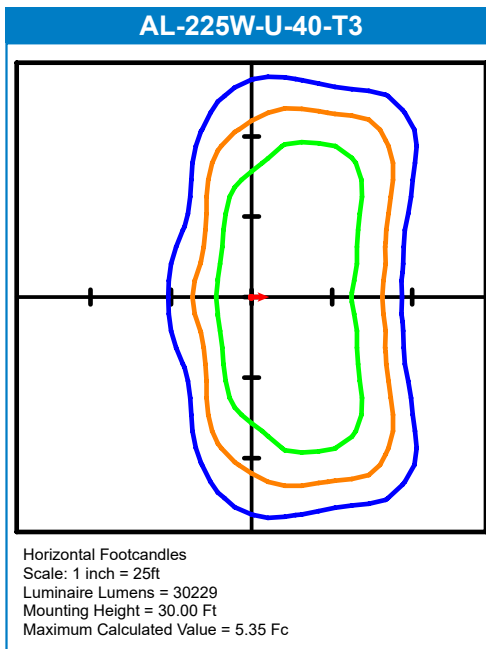
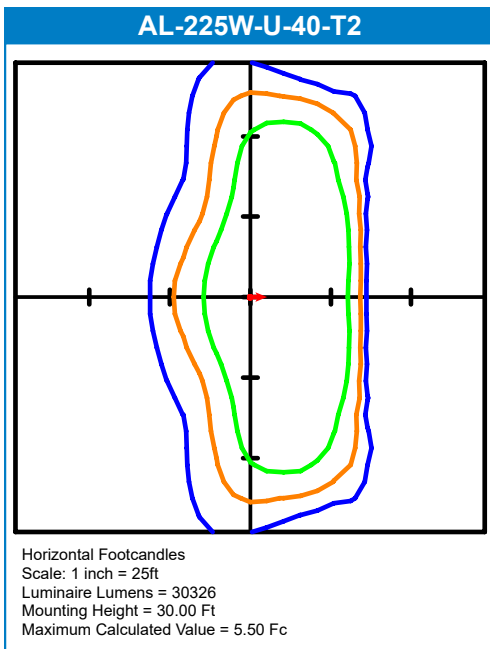
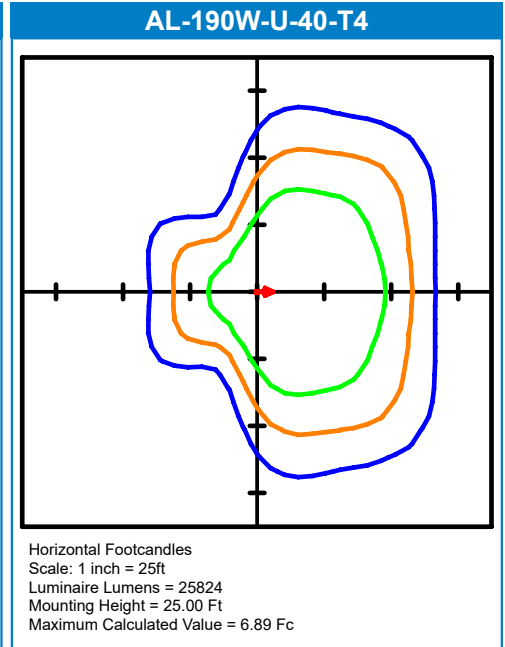
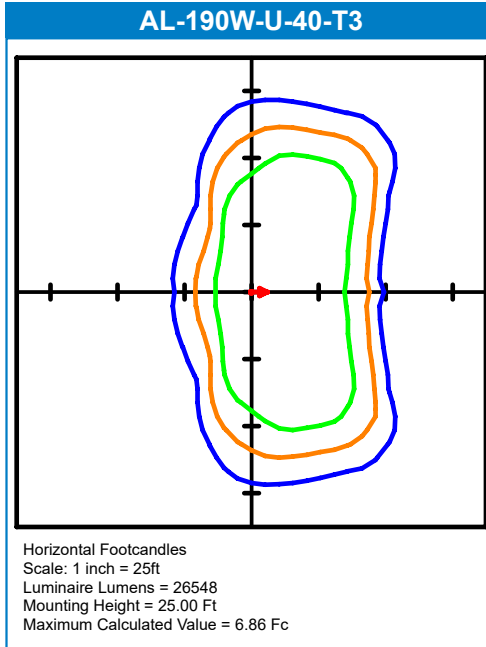
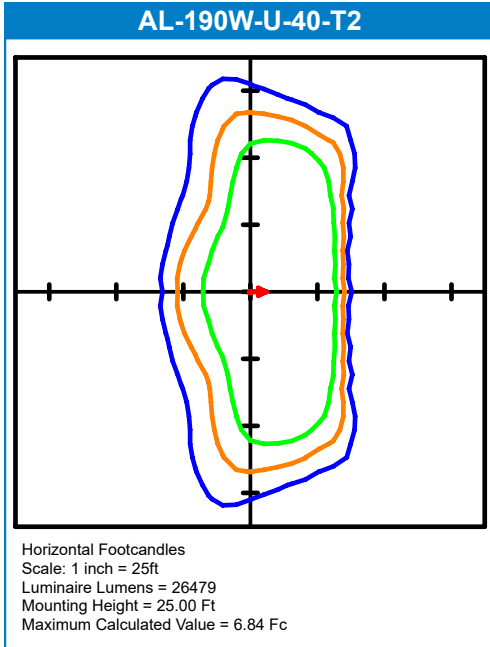

AREA LIGHT SERIES

OUTDOOR

PHOTOMETRIC REPORTS

Photometric values based upon tests performed in compliance with LM-79. IES files can be downloaded at www.ilp-inc.com
Blue = .5 fc, Orange = 1 fc, & Green = 2 fc

AL-270W-U-40-T2

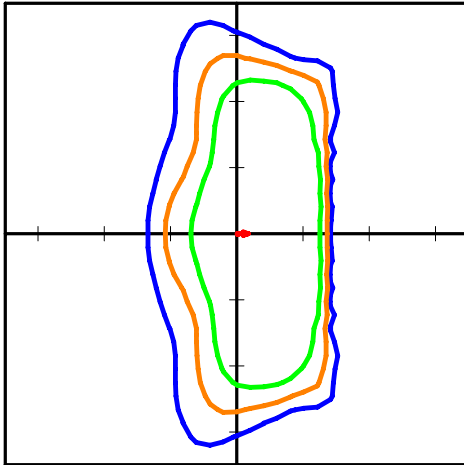

Horizontal Footcandles
Scale: 1 inch = 20ft
Luminaire Lumens = 40930
Mounting Height = 30.00 Ft
Maximum Calculated Value = 7.53 Fc

AL-270W-U-40-T3

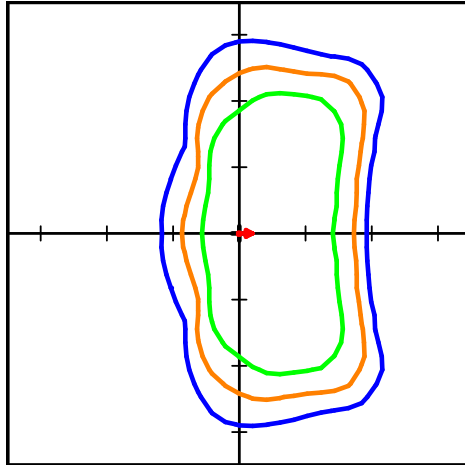

Horizontal Footcandles
Scale: 1 inch = 30ft
Luminaire Lumens = 40520
Mounting Height = 30.00 Ft
Maximum Calculated Value = 7.22 Fc

AL-270W-U-40-T4

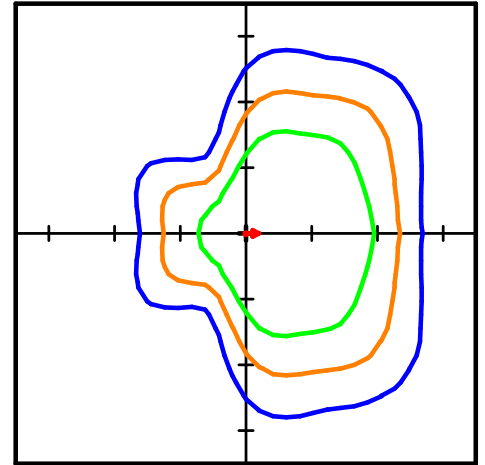

Horizontal Footcandles
Scale: 1 inch = 30ft
Luminaire Lumens = 38832
Mounting Height = 30.00 Ft
Maximum Calculated Value = 7.22 Fc

AL-375W-U-40-T2

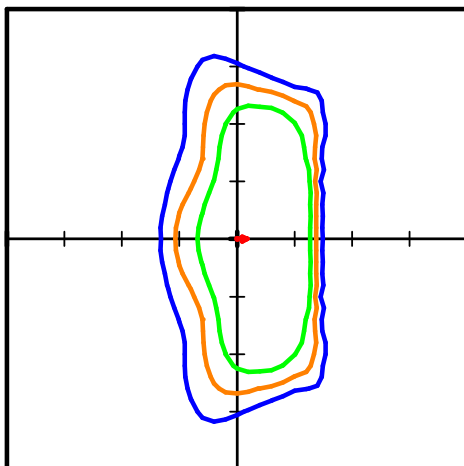

Horizontal Footcandles
Scale: 1 inch = 40ft
Luminaire Lumens = 52278
Mounting Height = 35.00 Ft
Maximum Calculated Value = 7.01 Fc

AL-375W-U-40-T3

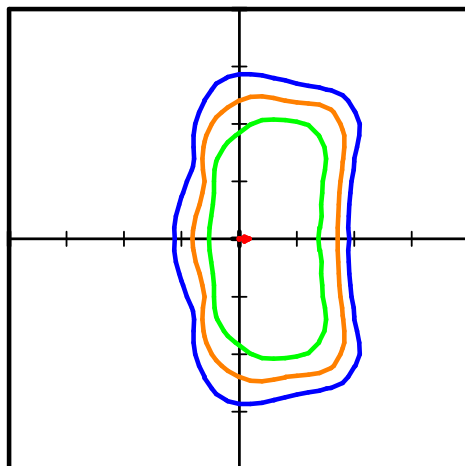

Horizontal Footcandles
Scale: 1 inch = 40ft
Luminaire Lumens = 52158
Mounting Height = 35.00 Ft
Maximum Calculated Value = 7.18 Fc

AL-375W-U-40-T4

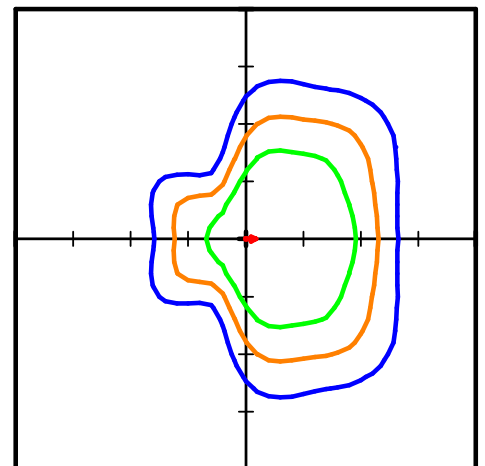

Horizontal Footcandles
Scale: 1 inch = 40ft
Luminaire Lumens = 50676
Mounting Height = 35.00 Ft
Maximum Calculated Value = 6.91 Fc