

Project Name:	Part Number:	Type:
---------------	--------------	-------



EVEREST

LINEAR HIGH BAY



407-478-3759
www.ilp-inc.com

SCAN



Product Overview

FEATURES

- Versatile 2', 3', & 4' housing delivering 12,000 – 56,000 lumens
- Slim Profile post painted steel housing for maximum rigidity
- Toolless Hinged Driver Access
- Wide & Narrow Distributions
- Impact Resistant and IP5X Rated Lens Options:
 - Frosted Acrylic (FRL)
 - Clear Polycarbonate (PCL)
- V-Clips for dual point chain or cable hanging (std.)
- -4°F–122°F Ambient Temperature Range
- 4000K–5000K CCT
- >80 Color Rendering Index (CRI)
- Calculated L70 >100,000 hrs
- 0-10V Dimmable Driver (100%–10%)
- 5 Year Warranty (std); 10 Year Warranty Optional
- ETL Listed for Damp Location



*Shown with FSP-311 Sensor Option



SUITABLE APPLICATIONS

- Warehouses • Distribution Centers • Gymnasiums • Manufacturing Plants



ORDERING GUIDE

SERIES	LUMENS	VOLTAGE	CCT	LENS	DISTRIBUTION	WARRANTY
EVT 2 ft. Everest	12L 12,000 lm	U 120-277v	40 4000K	FRL Frosted Acrylic Lens (Std)	(Blank) Wide	(Blank) 5YR
	18L 18,000 lm		50 5000K	PCL Polycarbonate Clear Lens		
	24L 24,000 lm			(Blank) No Lens		
	30L 30,000 lm					
EVT 3 ft. Everest	36L 36,000 lm					
	42L 42,000 lm					
EVT 4 ft. Everest	48L 48,000 lm					
	56L 56,000 lm					

OPTIONS - FACTORY INSTALLED

Cx/3W	3-wire cord standard fixtures (xFT = Length; x=6,10,15,20)
Cx/4W	4-wire cord for EM fixtures (xFT = Length; x=6,10,15,20)
Cx/5W	5-wire cord for non EM fixtures with external dim control (xFT = Length; x=6,10,15,20)
Cx/6W	6-wire cord for EM fixtures with external dim control (xFT = Length; x=6,10,15,20)
QDx/3W	3-wire Quick Connect standard fixtures (xFT = Length; x=6,10,15,20)
QDx/4W	4-wire Quick Connect for EM fixtures (xFT = Length; x=6,10,15,20)
QDx/5W	5-wire Quick Connect for non EM fixtures with external dim control (xFT = Length; x=6,10,15,20)
QDx/6W	6-wire Quick Connect for EM fixtures with external dim control (xFT = Length; x=6,10,15,20)
EM5 ^{1,2,10,15}	5W Battery Backup
EM5/HE ^{1,2,10,15}	5W Battery Backup - CEC Title 20 Compliant
EM7 ^{1,2,10,15}	7W Battery Backup
EM7/HE ^{1,2,10,15}	7W Battery Backup - CEC Title 20 Compliant
EM10 ^{1,2,10,15}	10W Battery Backup
EM10/HE ^{1,2,10,15}	10W Battery Backup - CEC Title 20 Compliant
EM10/HE/SD ^{1,2,10,15}	10W Self Diagnostic - Battery Backup - CEC Title 20 Compliant
EM12 ^{1,2,10,15}	12W Battery Backup
EM20 ^{1,2,10,15}	20W Battery Backup - CEC Title 20 Compliant
EM25 ^{1,2,10,15}	25W Battery Backup
EM25/HE ^{1,2,10,15}	25W LED Battery Backup - CEC Title 20 Compliant
EM25/HE/SD ^{1,2,10,15}	25W LED Battery Backup - CEC Title 20 Compliant - Self Diagnostic
GTD ^{1,2}	Generator Transfer Device UL924
SD480 ^{1,2}	480V Step Down Transformer
SD347 ^{1,2}	347V Step Down Transformer
RRLA ¹⁸	RELOC Ready Luminaire - Hot conductor wired to position #1 (phase A); non-dimming
RRLB ¹⁸	RELOC Ready Luminaire - Hot conductor wired to position #2 (phase B); non-dimming
RRLAE ^{18,19}	RELOC Ready Luminaire - Hot conductor wired to position #1 (phase A), hot conductor #2 wired to position #2 (phase B); non-dimming
2EA10/LW ¹⁶	ATKORE ACS FLEX3+ 10' Fixture Drop - 277/480V - 3-Wire Phase A #16AWG for use on 20A Branch Circuits
2EB10/LW ¹⁶	ATKORE ACS FLEX3+ 10' Fixture Drop - 277/480V - 4-Wire Phase A #16AWG for use on 20A Branch Circuits
2ED10/LW ¹⁶	ATKORE ACS FLEX3+ 10' Fixture Drop - 277/480V - 3-Wire Phase B #16AWG for use on 20A Branch Circuits

CONTROL OPTIONS - BASIC

FIOS ^{3,8}	On/Off Occupancy Sensor
FIOSPC ^{3,8}	On/Off Occupancy Sensor w/ Photocell
FIOSPC/DLH ^{3,8}	On/Off Occupancy Sensor w/ Daylight Harvesting
DHPC ^{3,8}	Daylight Harvesting Photocell
USBD ^{3,8}	User Selectable Bi-Level Dimming Occupancy Sensor
BDxx ^{3,8}	Preset Bi-Level Dimming Occupancy Sensor (xx=% eg. 20,30)
BDxxPC ^{3,8}	Preset Bi-Level Dimming Occupancy Sensor (xx=% eg. 20,30) w/ Photocell

CONTROL OPTIONS - ADVANCED

ESMC/HB ^{1,3,4}	EasySense High Bay Sensor
FSP-311/Lx ⁷	Legrand FSP-311 120/277V Sensor (X = Mounting Height 3=10-20', 7=20-40')
5S/CU/CL ^{7,11}	Enlighted Connected Lighting (CL) Sensor
5S/CU/IOT ^{7,10}	Enlighted Internet of Things (IOT) Sensor
SYN ¹⁶	Synapse Control System
SYNS/x ^{7,16}	Synapse Control System w/ Sensor (X = Mounting Height 3=10-20', 7=20-40')
AWN	Lutron Athena Option
CS/xxxx ¹⁷	Consult Factory Customer Supplied Controls

SHIP WITH ACCESSORIES

WC	11ga Wire Cage
HUB 3/4 ^{6,11}	Conduit Hub 3/4" for pendant mounting
HOOK ^{6,11}	Cast Iron Hook for single point mounting
ACY	Adjustable Y-Toggle aircraft cable set (x = 5' or 10')
EVT SMB ¹⁵	Surface Mount Bracket
EVT CPMB ^{5,6,13,14}	Center Point Mounting Bracket
EVT CPMB-3FT ^{5,6,12,14}	Center Point Mounting Bracket Kit for 3ft Fixtures
ESMC/WWS/DR	EasySense Dual Rocker Wireless Wall Switch

- Cannot be used with CPMB, HUB, HOOK, or SMB
- Externally mounted to fixture
- Sensor mounted off end cap of fixture
- Requires bluetooth enabled device for programming (provided by others)
- Must be used with HUB 3/4 or HOOK
- Must be used with ACSY for EVT-12L, 36L, 42L
- Center Mounted Sensor
- Operation down to 14F
- Operation down to 40F
- Operation down to 32F
- Must be used with CPMB
- Can only be used with EVT-36L and 42L
- Can only be used with EVT-12L, 18L, 24L, 30L, 48L, and 56L
- Not compatible with top-mounted options (e.g. battery backups and step-downs)
- Not compatible with SD347 or SD480 options
- Requires Site Layout, Consult Factory
- Consult Factory for more details
- Consult Factory quote for RELOC OCU, OCS, OD System Drops; System Drops Sold & Shipped Separately; Retrofit Applications Only
- Disconnect the TSPL before unplugging the RRL so it does not go into discharge mode. Requires fixture to have battery option.



EVEREST

LINEAR HIGH BAY



QUICK SHIP ORDERING:

SERIES	LUMENS	VOLTAGE	CCT	LENS	DISTRIBUTION	WARRANTY
EVT Everest	12L 12,000 lm 18L 18,000 lm 24L 24,000 lm 30L 30,000 lm 36L 36,000 lm 42L 42,000 lm 48L 48,000 lm 56L 56,000 lm	U 120-277v	40 4000K 50 5000K	FRL Frosted Acrylic Lens (Std)	(Blank) Wide	(Blank) 5YR 10YR 10YR

LED SYSTEMS INFO ¹	4000K		5000K		Watts ²	Replaces	DLC Listing ³
	Part Numbers	Lumens	Efficacy	Lumens			
EVT-12L-U-xx	13615	149	13591	149	90	175W MH, 2T5HO	N/A
EVT-12L-U-xx-ND	13364	147	13320	147			PREMIUM
EVT-12L-U-xx-FRL	12808	141	12777	141			PREMIUM
EVT-12L-U-xx-FRL-ND	12572	139	12522	139			PREMIUM
EVT-12L-U-xx-PCL	12424	137	12394	137			N/A
EVT-12L-U-xx-PCL-ND	12195	135	12146	135			N/A
EVT-18L-U-xx	19605	147	19580	147	130	250W MH, 4T5HO	N/A
EVT-18L-U-xx-ND	19203	145	19242	145			PREMIUM
EVT-18L-U-xx-FRL	18285	138	18328	138			PREMIUM
EVT-18L-U-xx-FRL-ND	17910	136	18012	136			PREMIUM
EVT-18L-U-xx-PCL	17736	134	17778	134			N/A
EVT-18L-U-xx-PCL-ND	17372	132	17472	132			N/A
EVT-24L-U-xx	26753	147	26624	147	180	400W MH, 6T5HO	N/A
EVT-24L-U-xx-ND	26208	145	26178	145			PREMIUM
EVT-24L-U-xx-FRL	24955	138	24835	138			PREMIUM
EVT-24L-U-xx-FRL-ND	24447	136	24419	136			PREMIUM
EVT-24L-U-xx-PCL	24206	134	24090	134			N/A
EVT-24L-U-xx-PCL-ND	23714	132	23686	132			N/A
EVT-30L-U-xx	31239	142	31089	141	220	575W MH, 10T8	N/A
EVT-30L-U-xx-ND	30603	139	30568	139			PREMIUM
EVT-30L-U-xx-FRL	29140	132	29000	132			PREMIUM
EVT-30L-U-xx-FRL-ND	28547	130	28514	130			PREMIUM
EVT-30L-U-xx-PCL	28266	128	28130	128			N/A
EVT-30L-U-xx-PCL-ND	27691	126	27659	126			N/A
EVT-36L-U-xx	39116	143	39245	144	270	750W MH, 8T5HO	N/A
EVT-36L-U-xx-ND	38174	140	38017	139			PREMIUM
EVT-36L-U-xx-FRL	37252	137	37360	137			PREMIUM
EVT-36L-U-xx-FRL-ND	36355	133	36191	133			PREMIUM
EVT-36L-U-xx-PCL	36134	132	36239	133			N/A
EVT-36L-U-xx-PCL-ND	35264	129	35105	129			N/A
EVT-42L-U-xx	45981	149	46746	152	300	1000W MH, 10T5HO	N/A
EVT-42L-U-xx-ND	43414	141	43473	141			PREMIUM
EVT-42L-U-xx-FRL	42288	137	42914	139			PREMIUM
EVT-42L-U-xx-FRL-ND	39927	130	39909	129			PREMIUM
EVT-42L-U-xx-PCL	41019	133	41627	135			N/A
EVT-42L-U-xx-PCL-ND	38729	126	38712	125			N/A
EVT-48L-U-xx	52608	154	52148	154	345	1000W MH, 10T5HO	N/A
EVT-48L-U-xx-ND	48528	142	48573	144			PREMIUM
EVT-48L-U-xx-FRL	47748	140	47982	143			PREMIUM
EVT-48L-U-xx-FRL-ND	44045	129	44693	133			PREMIUM
EVT-48L-U-xx-PCL	46316	136	46543	138			N/A
EVT-48L-U-xx-PCL-ND	42724	125	43352	129			N/A
EVT-56L-U-xx	60858	149	61761	152	400	1000W MH, 10T5HO	N/A
EVT-56L-U-xx-ND	57424	142	57705	142			PREMIUM
EVT-56L-U-xx-FRL	56106	138	57053	141			PREMIUM
EVT-56L-U-xx-FRL-ND	52940	131	53306	132			PREMIUM
EVT-56L-U-xx-PCL	54423	134	55341	137			N/A
EVT-56L-U-xx-PCL-ND	51352	127	51707	128			N/A

¹Values are nominal, see IES file for more detail ²Electrical data at 25C (77F). Actual wattage may differ by +/-10%. ³All EVT versions may not be DLC listed, check QPL



EVEREST

LINEAR HIGH BAY

ELECTRICAL DATA (AMPS)*

Lumen Package	120V	208V	240V	277V	347V	480V
12L	0.75	0.43	0.38	0.32	0.29	0.21
18L	1.08	0.63	0.54	0.47	0.41	0.30
24L	1.50	0.87	0.75	0.65	0.57	0.41
30L	1.83	1.06	0.92	0.79	0.70	0.50
36L	2.25	1.30	1.13	0.97	0.86	0.62
42L	2.50	1.44	1.25	1.08	0.95	0.69
48L	2.88	1.66	1.44	1.25	1.09	0.79
56L	3.33	1.92	1.67	1.44	1.27	1.27

*Electrical data at 25C (77F). Actual wattage may differ by +/-10%.

SPECIFICATIONS

CONSTRUCTION

The Everest series Highbay features a slim profile rugged steel housing for maximum flexing prevention. The EVT is available in 2', 3', or 4' lengths for a fully scalable solution. Thumbs screws and a hinged driver door provide toolless access for ease of maintenance and installation. Power access plate mounted on back of center driver channel for easy access to wiring.

OPTICS

Standard with impact resistant frosted acrylic lens (FRL) for added LED glare reduction. Optional clear polycarbonate lens (PCL) available. High performance snap on factory/field installed Narrow distribution optic available on all lumen packages. Both optics are IP5X rated; protected against dust intrusion.

ELECTRICAL

Class 2 High-performance drivers features over-voltage, under-voltage, short circuit and over temperature protection. L70 >100,000 hrs. in accordance with IESNA TM-21-19 projected values at 25°C Ambient temperature. Power Factor > 0.90. Standard 120-277 Vac 50/60Hz 0-10V dimmable (10% - 100%) with optional 347V – 480 Vac step down transformer. Optional emergency battery backups and generator transfer device available to meet critical life safety lighting requirements. Reduced fixture maximum ambient on emergency battery backup and step-down options, consult factory. Input power stays constant over life. Additional surge protection is available in 10kV and 20kV options.

THERMAL

The Everest Series features an array of High-efficacy LED's mounted on a metal core circuit board. The LED boards are mounted directly to the aluminum housing to provide excellent thermal performance extending the life of electronic components. Operating Ambient Temperature: -20°C to +50°C (-4°F to 122°F).

INSTALLATION

Options include suspension chain, aircraft cables, hook, single pendant (HUB), surface mount (EVT SMB). Reduced maximum ambient range for surface mount.

CONTROLS

Standalone Controls:

Optional PIR sensors available installed in housing hinged door or end mounted. Sensors provide optional on/off control, High end/low end trim, continuous dimming, daylight harvesting, bi-level dimming, and bluetooth configuration allows for on-site modifications depending on the model chosen. See control page for detailed information.

Wireless Control Systems:

The Everest Series is wireless mesh controls ready with Easy Sense, Enlighted, and Synapse wireless control platforms. Inquire with factory for more information or for additional controls options, including customer supplied items.

WARRANTY

5 Year Warranty Standard; 10 Year Warranty Optional (Terms and Conditions apply).

CERTIFICATIONS

ETL Listed for damp locations, suitable for ground mounting. Tested in accordance with IESNA LM-79 and LM-80 standards. DesignLights Consortium® (DLC) Premium qualified product. Not all versions of this product may be DLC Premium qualified. Please check the DLC Qualified Products List at www.designlights.org/QPL to confirm which versions are qualified.



CONTROLS OPTIONS

BASIC

FIOS

Standard on/off motion sensor. Comes with 360 degree high bay lens, 360 degree low bay lens & aisle lens. 360 degree high bay lens factory installed, unless notified otherwise. Sensor mounted off end cap of fixture. Inquire for mounting on center of driver cover.

FIOSPC

Motion sensor with the addition of photocell control. When installed, fixture will not activate unless 1. motion is detected and 2. light levels are below the preset level. When activated, fixture will turn on to 100% light output & will only shut off when one of the two levels mentioned above are met. If no motion is detected & light levels fall below preset level the fixture remains off. Sensor mounted off end cap of fixture.

FIOSPC/DLH

Factory installed motion sensor with the addition of photocell control that will allow for daylight harvesting. When installed, fixture will not activate unless 1. motion is detected & 2. light levels are below the preset level. When activated, fixture will turn on only enough to meet the preset light levels and will adjust as the amount of light in the space adjusts between 100%-10%. If light levels are adequate the fixture will remain off. Sensor mounted off end cap of fixture.

DHPC

Daylight Harvesting off photocell. Fixtures will continually dim up/down throughout the day based on light level readings taken from the photocell control. Sensor mounted off end cap of fixture.

ADVANCED

Philips ESMC/HB

EasySense sensor combines occupancy sensing, daylight harvesting and institutional tuning in one compact solution. This is an ideal control for any high bay application. Each device allows you to turn on/off occupancy and/or daylight harvesting functions as well as set the full light output, background light level, occupancy prolong time, occupancy grace fading time & occupancy time out/hold time. Easily Controlled via Mobile Phone with Philips MasterConnect Bluetooth App. (Sold separately). Sensor mounted off end cap of fixture.

Legrand FSP-311

FSP-311 offers fully adjustable high and low dimmed light levels with optional photocell. Hold off setpoint with automatic calibration option. Adjustable time delay and cut off delay. Sensor adjustable programming via iOS® or Android® 'Sensor Configuration' App. Sensor mounted on center driver channel.

Lutron AWRN

Athena wireless node is a radio frequency (RF) device that enables simple, digital control of individual light fixtures in an Athena control system. Enables individual wireless control of each fixture in an Athena control system. Accommodates zone and control changes without rewiring. All drivers on the link are controlled as a single zone. Provided with factory installed components only. Lutron Athena system provided by others.

Synapse

Utilizing a robust 2.4 GHz Self-Healing Mesh Network, Synapse provides flexibility and scalability making it a perfect industrial solution for both new construction and retrofit projects. The easy-to-use web application is accessible on any device with an internet connection and allows for complete customization of the system and its features. Integral radio (SYN) includes (2) 24V inputs for a Wattstopper sensor. Sensors available in 20' or 40' mounting lenses. Sensor mounted on hinged driver cover. Antenna exits side of luminaire for maximum connectivity.

USBD

User Selectable Bi-Level Dimming. Allows the end user to manually select the unoccupied dimming level. Once motion is detected, the fixture will return to 100% light output. Sensor mounted off end cap of fixture.

BDxx

Factory set Bi-Level Dimming. Sensor is set to dim level, as indicated in the "xx" portion of the part number, when the area is unoccupied. Example: BD20 sets the fixture to dim down to 20% lumen output when the area is unoccupied. Once motion is detected, the fixture will return to 100% light output. Sensor mounted off end cap of fixture.

BDxxPC

Factory set Bi-Level Dimming with motion and photocell. Sensor is set to dim level, as indicated in the "xx" portion of the part number, when the area is unoccupied and will not return to 100% light output unless 1. motion is detected and 2. the light level is below the preset level. Example: BD20PC sets the fixture to dim down to 20% lumen output when the area is unoccupied and will not return to 100% light output unless the above conditions are met for both motion and light level readings. Sensor mounted off end cap of fixture.

Enlighted 5S/CU/CL

Bundled System with Enlighted Sensor. Fixtures are controlled based on occupancy & ambient light. Includes individual lighting control plus connection to Enlighted Energy Manager. The Energy Manager provides data analysis for all data collected by the Enlighted Smart Sensors for energy, occupancy & environment. Provided factory installed components only. Enlighted system provided by others. Contact factory for more information. Sensor mounted on center driver channel.

Enlighted 5S/CU/IOT

Bundled System with Enlighted Sensor. Fixtures are controlled based on occupancy and ambient light. Includes individual lighting control plus connection to Enlighted Energy Manager. The Energy Manager provides data analysis for all data collected by Enlighted Smart Sensors for energy, occupancy & environment. Additionally, the IOT functionality takes the data access and function beyond just lighting to a wide range of applications beyond the standard connected lighting controls. Provided factory installed components only. Enlighted system provided by others. Contact factory for more information. Sensor mounted on center driver channel.



EVEREST LINEAR HIGH BAY

OPTIONS



Cx/yW

Cords - (x = 6, 10, 15, 20 (ft)) (y = conductors; 3, 4, 5, 6) Plug options available



QDx/yW

Quick Disconnect - (x = 6, 10, 15, 20 (ft)) (y = conductors; 3, 4, 5, 6)

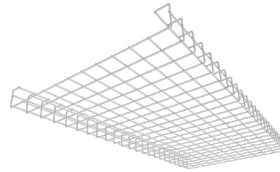

WC

11 GA Wire Cage

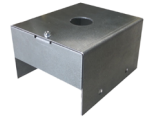

CPMB

Includes rigid box to attach to the fixture, provides for single point mounting to accept a pendant, hook or conduit hub (sold separately)



HUB 3/4

Conduit Hub 3/4" for Pendant Mounting



HOOK

Cast Iron Hook for Single Point Mounting



ACxY

Includes 2 adjustable cable hangers. Available in 5' or 10'



EVT SMB

Surface Mount Bracket Kit provides a 2" space above the fixture

LINE DRAWINGS

2FT Nominal Length (12L – 30L)

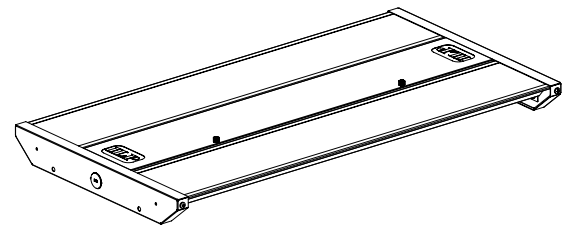
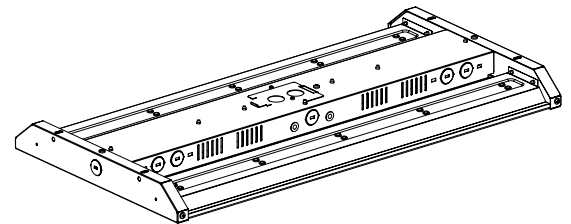
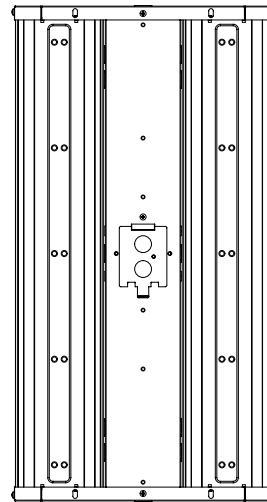
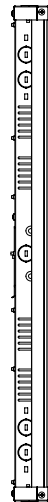
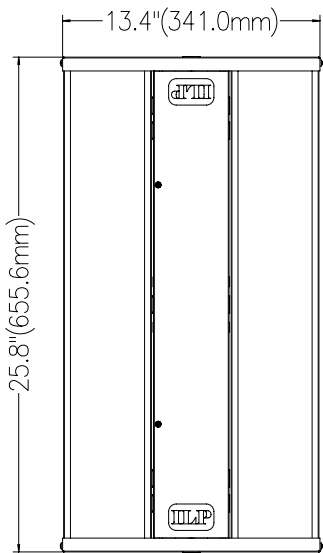

1.8\"(46.3mm)



EVEREST LINEAR HIGH BAY

3FT Nominal Length (36L - 42L)

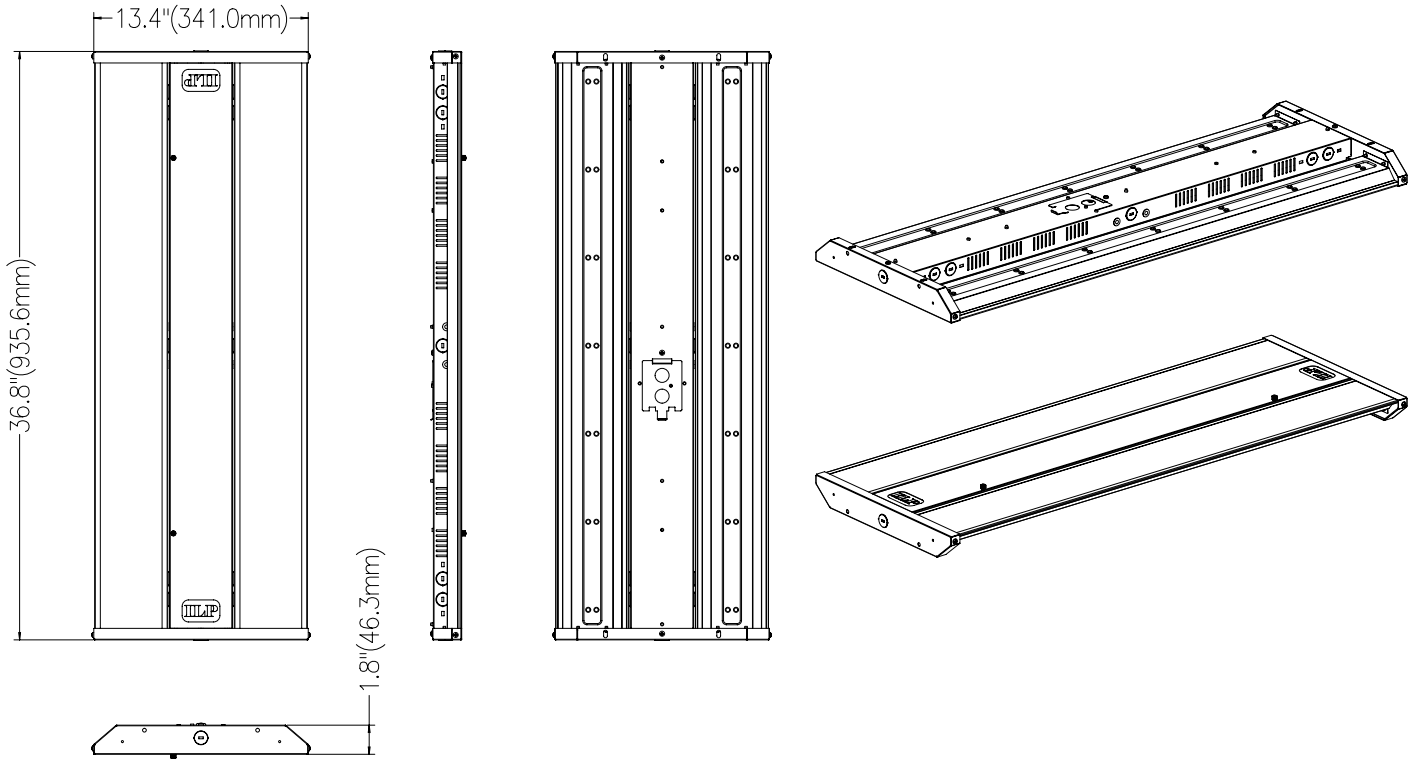

4FT Nominal Length (48L-56L)

