



## MaxLite® LED Low-Profile Garage & Canopy Luminaire

### General Safety Information

- To reduce the risk of death, personal injury or property damage from fire, electric shock, falling parts, cuts/abrasions, and other hazards read all warnings and instructions included with and on the fixture box and all fixture labels.
- Before installing, servicing, or performing routine maintenance upon this equipment, follow these general precautions.
- Commercial installation, service and maintenance of luminaires should be performed by a qualified licensed electrician.
- **DO NOT INSTALL DAMAGED PRODUCT!**
- This fixture is intended to be connected to a properly installed and grounded UL listed junction box.



Picture is for illustration purposes only. Your model may vary.

#### **WARNING:**

##### **RISK OF ELECTRICAL SHOCK**

- Turn off electrical power at fuse or circuit breaker box before wiring fixture to the power supply.
- Turn off the power when you perform any maintenance.
- Verify that supply voltage is correct by comparing it with the luminaire label information.
- Make all electrical and grounded connections in accordance with the National Electrical Code and any applicable local code requirements.
- All wiring connections should be capped with UL approved wire connectors.

#### **CAUTION:**

##### **RISK OF INJURY**

- Wear gloves and safety glasses at all times when removing luminaire from carton, installing, servicing or performing maintenance.
- Avoid direct eye exposure to the light source while it is on.
- Account for small parts and destroy packing material, as these may be hazardous to children.

#### **CAUTION:**

##### **RISK OF FIRE**

- Keep combustable and other materials that can burn away from luminaire and lamp/lens
- Do not mount to flammable or combustible surfaces.
- **MIN 75°C SUPPLY CONDUCTORS.**

**Input Rating:** 120V-277V 50/60Hz

**Operating Temperature:** -40°F to 104°F

Models:

**CPL Series**

# MaxLite® LED Low-Profile Garage & Canopy Luminaire

## General Wiring Diagram

**⚠ WARNING**

**CAUTION:** Turn off electrical power at fuse or circuit breaker box before wiring fixture to the power supply.

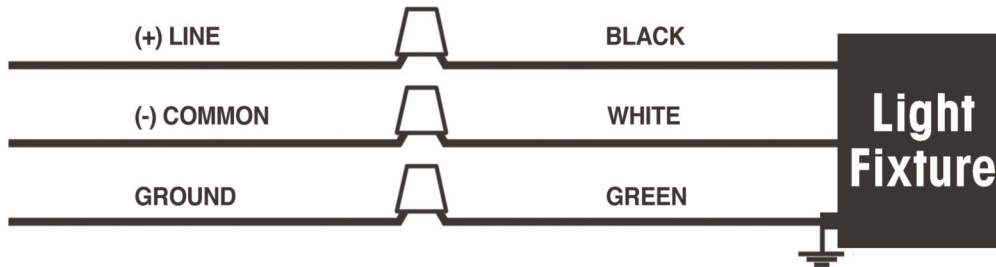

## Installation

### Surface Mount:

1. Unfasten surface mount plate side screw. **(Fig. 1)**
2. Slide surface mount plate out and up to remove. **(Fig. 2)**
3. Mount surface mount plate onto J Box. **(Fig. 3)**
4. Secure fixture onto surface mount plate by first hooking fixture onto ring. **(Fig. 4)**
5. Wire fixture (according to diagram above.)
6. Lift fixture and fasten with surface mount plate screw. **(Fig. 5)**

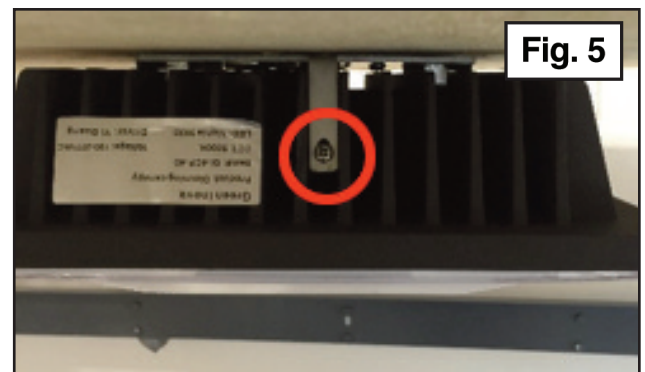
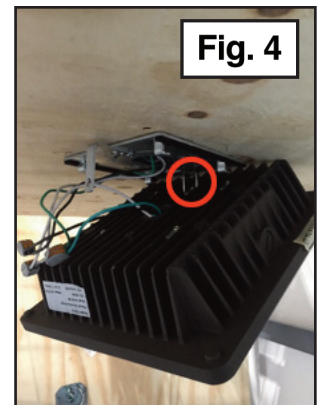
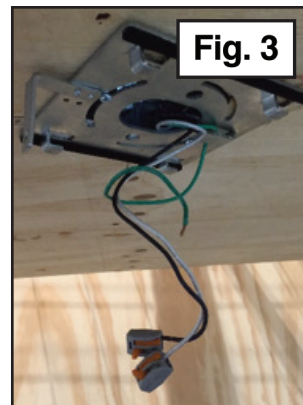
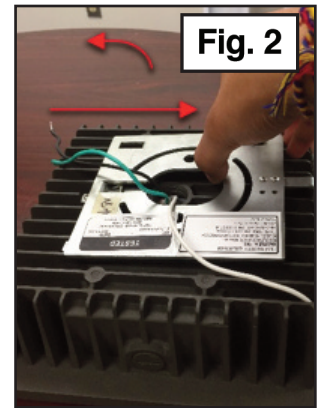
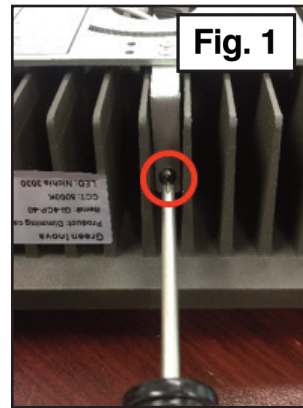

# MaxLite® LED Low-Profile Garage & Canopy Luminaire

## Installation

### Pendant Mount:

1. Remove lens by unfastening 4 screws with Allen key. **(Fig. 1)**
2. Remove white cover plate by unfastening 4 screws. **(Fig. 2)**
3. Remove driver by unfastening 2 screws. **(Fig. 3)**
4. **Note:** before screwing pipe onto fixture add one washer nut. Screw pendant onto fixture add washer nut and feed wires through pipe. **(Fig. 4)**
5. Secure pendant by tightening washer nut. **(Fig. 4)**
6. Reassemble driver, white cover plate, and lens.

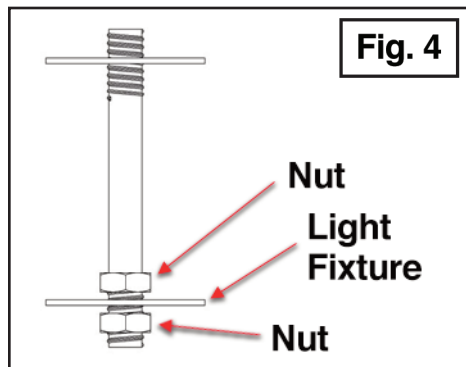
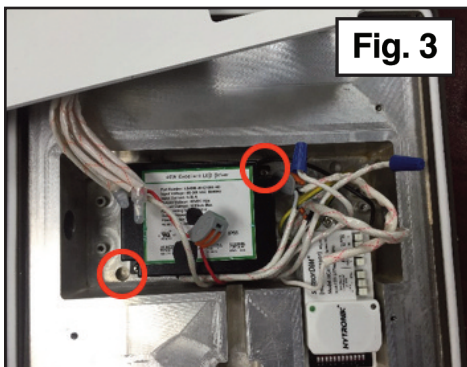
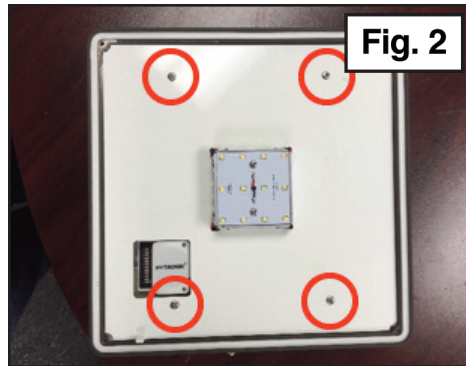
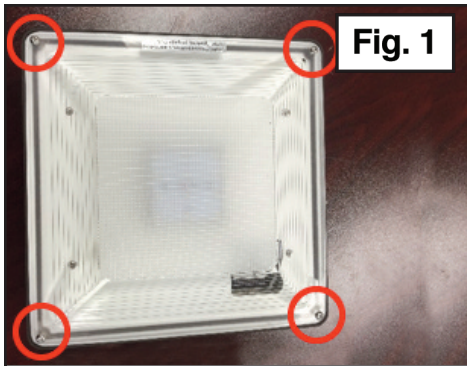



MaxLite® LED Low-Profile Garage & Canopy Luminaire

0°C Emergency Battery Back-up Wiring Instructions  
(Model numbers with suffix -EM0)

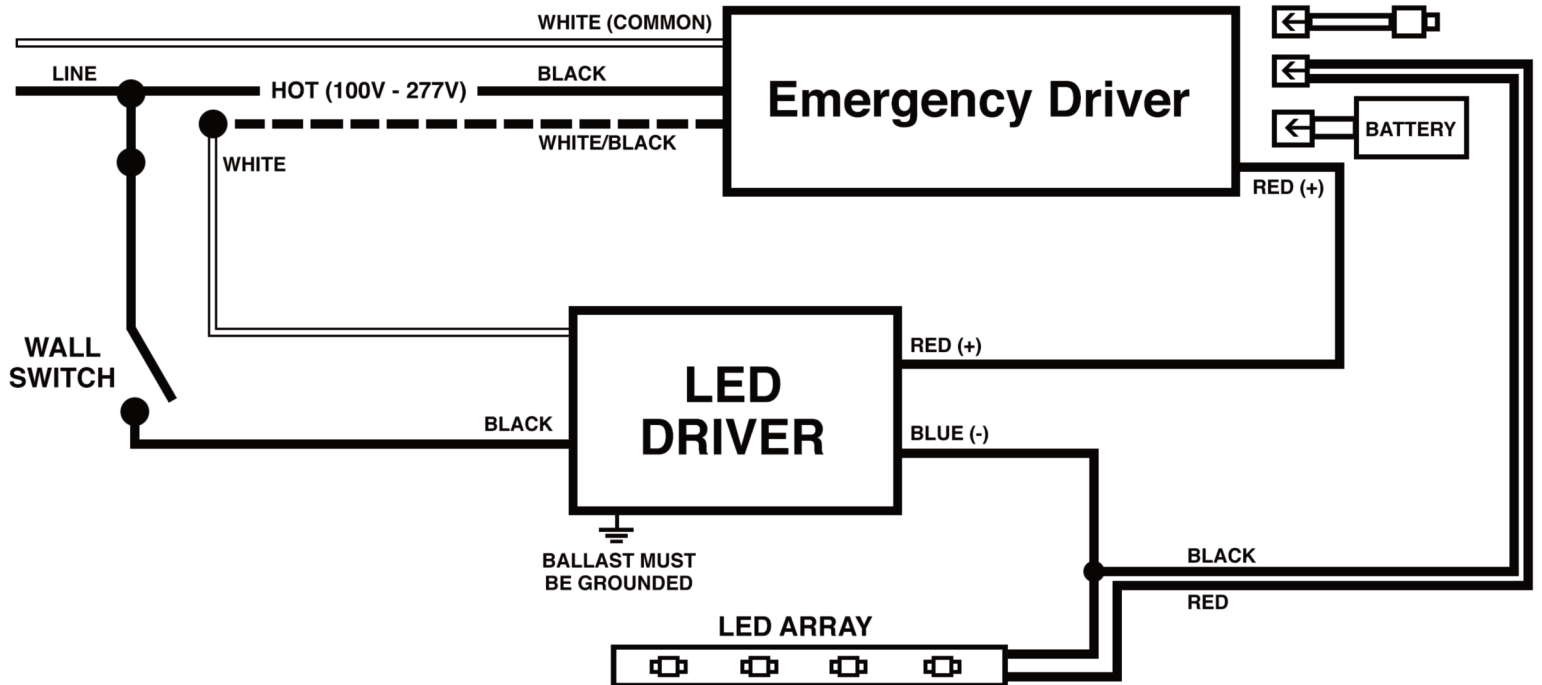

-20°C Emergency Battery Back-up Wiring Instructions  
(Model numbers with suffix -EM2)

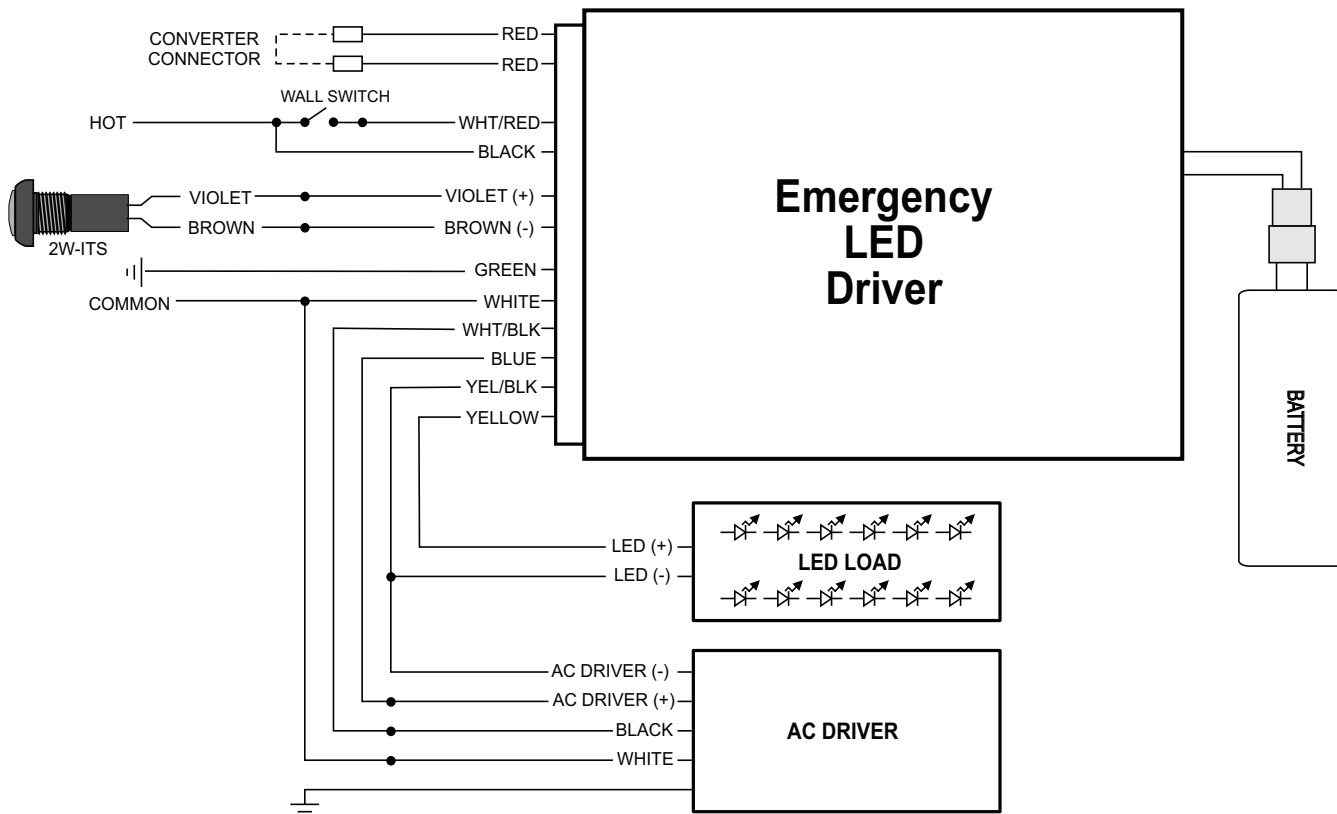



# MaxLite® LED Low-Profile Garage & Canopy Luminaire

## Motion Sensor Configuration Instructions

### Technical Specifications:

Item	Specification	MSHYTHC419VRC
Electrical Aspects	Operating Voltage	120-277VAC 50Hz/60Hz
	Max Load	400W@120Vac; 1000W@277Vac
	Standby Power	<1W
	Warm Time	20s
	Detection Area	50% /100% (100% /50% /10% on RC)
	Hold Time	2s /30s /1min /5min /10min /30min
	Standby Period	0s /10s /1min /10min /30min /1h /+∞
	Standby Dimming Level	10% /20% /30%
	Daylight Threshold	2~50Lux; disable
	Physical Aspects	Sensor Principle
Microwave Frequency		5.8GHz+/-75MHz
Microwave Power		<0.2mW
Detection Range		Max. 16 meters in diameter, adjustable
Detection Angle		30° ~ 150°
Mounting Height		≤15M
Operating Temperature		-20°C ~ +60°C
IP Rating		IP20, IP65(when mounted in rated enclosure)
Certificate		FCC, ETL, cULus

### Wiring Diagram: Wiring for single sensor

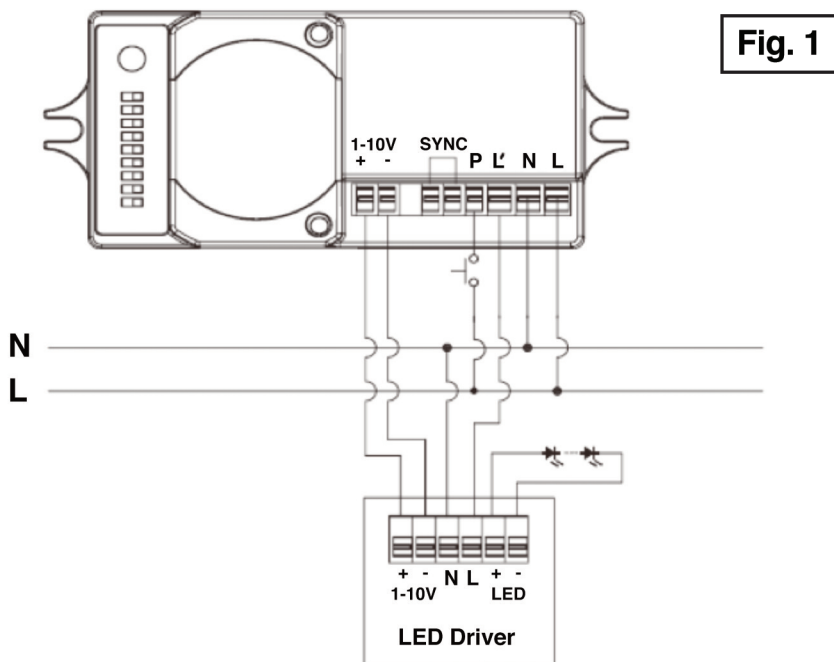



# MaxLite® LED Low-Profile Garage & Canopy Luminaire

## Motion Sensor Configuration Instructions

Wiring Diagram: Wiring for synchronization function

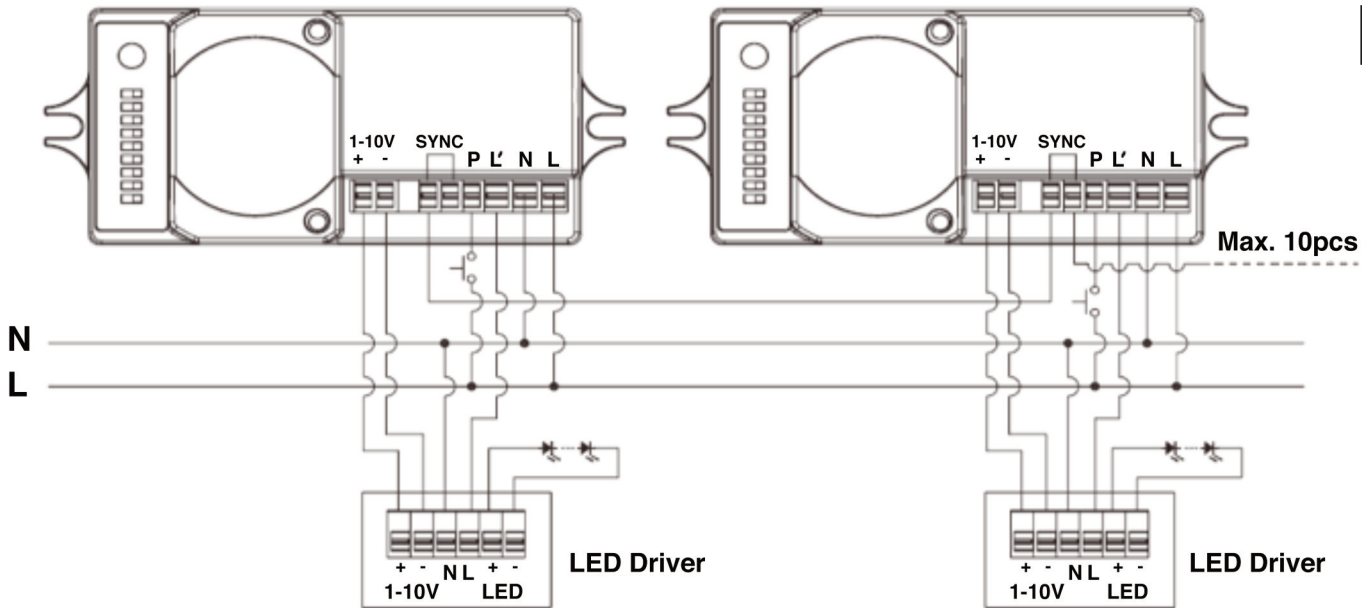

Fig. 2

**Note:** This 1-10V output is isolated, SELV output. Do not connect the 1-10V terminals on driver X to driver Y.

### Dimensions:

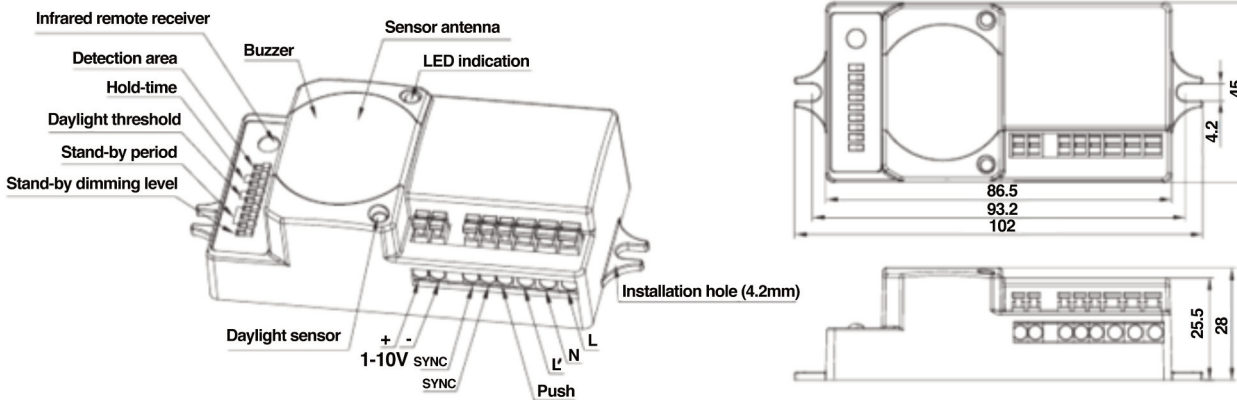

Fig. 3

### Detection Pattern:

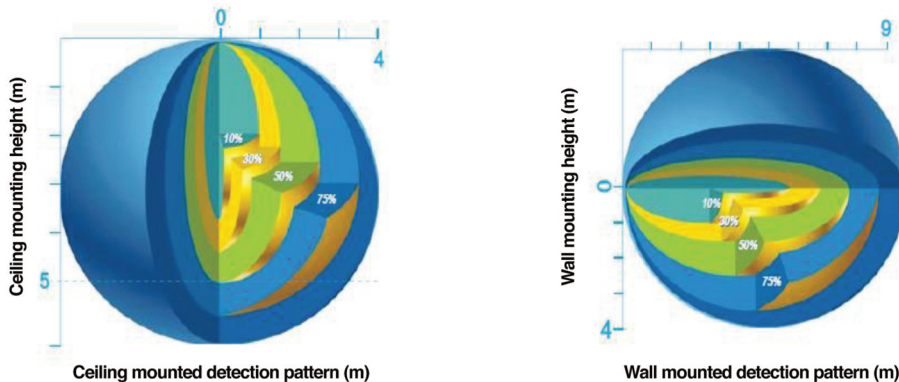

Fig. 4



# MaxLite® LED Low-Profile Garage & Canopy Luminaire

## Motion Sensor Configuration Instructions

**Fig. 5**

### Remote Control Settings:

#### Permanent ON/OFF (button 1)

1. Press button 1, the light goes to permanent ON or permanent OFF mode.
2. Press button 2, 3, 4 to quit from this mode. (Please refer to explanation accordingly)

#### Auto Mode (button 2)

Press button 2 goes to auto mode, the sensor starts working and all settings remain the same as the latest status before the light was switched ON/OFF.

#### RESET (button 3)

Press button 3, all settings go back to the value of DIP settings.

#### Test 2s function (button 8)

1. Press button 8, the sensor goes to test mode (hold time 2s), stand-by period and daylight sensor are disabled.
2. Press button 3, 4, 11 to quit from this mode, and the sensor setting is changed accordingly.

#### Ambient daylight threshold (button 10)

Press button 10, the latest surrounding lux value overwrites previous lux value learned, and is set as the daylight threshold. This feature enables the fixture to function well in any real application circumstance.

#### Power output (button 5)

Press button 5, the output shifts between 80% (at initial 10,000 hours) and 100%, for energy saving purposes.

#### Dim +/- (button 9)

Press button 9 to adjust the light brightness during hold-time. "+" means dimming up, "-" means dimming down.

#### Lux disable (button 14)

Press button 14, the built-in daylight sensor stops working, and all motion detected could turn on the lighting fixture, no matter how bright the natural light is.

#### Manual override / absence detection (button 15)

Press button 15, the sensor goes to manual override or absence detection function. Note: the buzzer beeps twice if it's in manual override function, and beeps once if shifts to absence detection function.

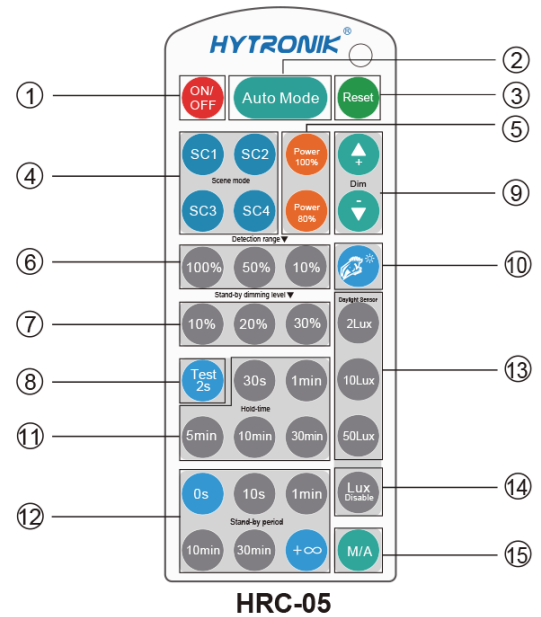

**Note:** the buzzer beeps one time when RC receives signal successfully.



# MaxLite® LED Low-Profile Garage & Canopy Luminaire

## Motion Sensor Configuration Instructions

### Remote Control Settings:

#### Detection range (zone 6)

Press buttons in zone 6 to set detection range at 100% / 50% / 10%.

#### Hold time (zone 11)

Press buttons in zone 11 to set hold time at 30s / 1min / 5min / 10min / 30min.

#### Stand-by period (zone 12)

Press buttons in zone 12 to set stand-by period at 0s / 10s / 1min / 10min / 30min / +∞. Note: “0s” means on/off control; “+∞” means bi-level of dimming control, light never switches off.

#### Stand-by dimming level (zone 7)

Press buttons in zone 7 to set the stand-by dimming level at 10% / 20% / 30%.

#### Daylight sensor (zone 13)

Press buttons in zone 13 to set daylight sensor at 2lux / 10lux / 50lux.

#### Scene mode options (zone 4)

There are 4 scene modes built-in the remote control for different applications:

Scene options	Detection range	Hold time	Stand-by period	Stand-by dimming level	Daylight sensor
SC1	100%	1min	10min	10%	2Lux
SC2	100%	5min	10min	10%	2Lux
SC3	100%	10min	30min	10%	10Lux
SC4	100%	10min	+∞	10%	50Lux

Note: end-user can adjust the settings by pressing buttons of detection range 6 / hold time 11 / stand-by period 12 / stand-by dimming level 7 / daylight sensor 13, the last setting stays in validity.

### DIP Switch Settings:

1. Remove lens by unfastening 4 screws with Allen key. (Fig. 6)
2. Remove white cover plate by unfastening 4 screws. (Fig. 7)
3. Choose from the switch settings outlined on next page.
4. Reassemble white cover plate and lens.

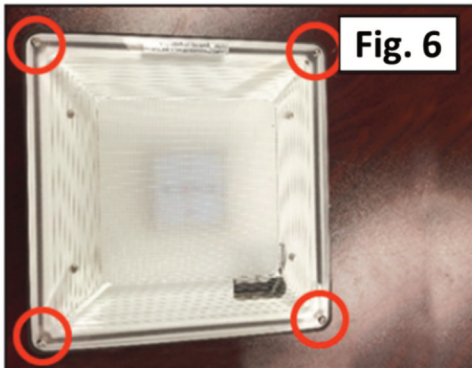

Fig. 6

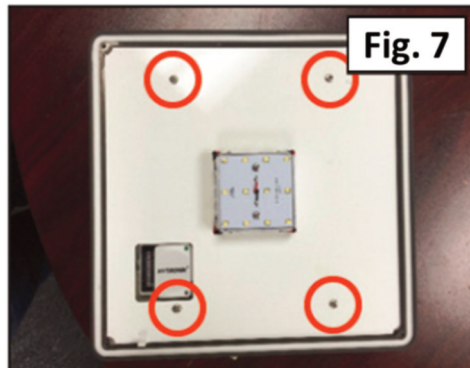

Fig. 7





# MaxLite® LED Low-Profile Garage & Canopy Luminaire

## Motion Sensor Configuration Instructions

### Detection area

Detection area can be reduced by selecting the combination on the DIP switches to fit precisely for each specific application.

- I – 100%
- II – 50%

	1	
I	●	100%
II	○	50%



### Hold-time

Hold-time means the time period to keep the lamp on 100%, after all motion has ceased (detection area vacated).

- I – 5s
- II – 3min
- III – 10min
- IV – 30min

	2	3	
I	●	●	5s
II	●	○	3min
III	○	●	10min
IV	○	○	30min



### Daylight sensor

The daylight threshold can be set on DIP switches, to fit for particular application.

- I – Disable
- II – 50Lux
- III – 10Lux
- IV – 2Lux

	4	5	
I	●	●	Disable
II	●	○	50Lux
III	○	●	10Lux
IV	○	○	2Lux



### Stand-by period (corridor function)

This is the time period you would like to keep at the low light output level before it is completely switched off in the long absence of people.

- I – 0s
- II – 10s
- III – 1min
- IV – 5min
- V – 10min
- VI – 30min
- VII – 1h
- VIII – +∞

	6	7	8	
I	●	●	●	0s
II	●	●	○	10s
III	●	○	●	1min
IV	●	○	○	5min
V	○	●	●	10min
VI	○	●	○	30min
VII	○	○	●	1h
VIII	○	○	○	+∞



Note: "0s" means on/off control;  
 "+∞" means bi-level dimming control, fixture never switches off when daylight sensor is disabled.

### Stand-by dimming level

This is the dimmed low light output level you would like to have after the hold-time in the absence of people.

- I – 10%
- II – 30%

	1	
I	●	10%
II	○	30%





# MaxLite® LED Low-Profile Garage & Canopy Luminaire

## Motion Sensor Configuration Instructions

### 4.1 Ambient Daylight Threshold

Switch the power supply to the sensor two times within 2 seconds, the sensor can set the ambient lux level as the new threshold. Both the settings on DIP switch and the ambient lux threshold learned can overwrite each other. This feature enables the daylight sensor to be commissioned to the environment in which it is installed. The latest action controls. (More details of the operation procedure please refer to user manual).

### 4.2 Zero-cross Relay Operation

Designed in the software, sensor switches on/off the load right at the zero-cross point, to ensure the in-rush current is minimised, enabling the maximum lifetime of the relay.

### 4.3 Synchronization Function

By connecting the “SYNC” terminals in parallel (maximum 10pcs, see wiring diagram), no matter which sensor detects motion, all HC419VRC/R in the group will turn on the lights when surrounding natural light is below daylight threshold. The sensor antenna is shared and the detection area could be widely enlarged in this way. Other settings such as hold-time, stand-by period, stand-by dimming level and daylight threshold on each individual unit stay the same.

**Note:** if the surrounding natural light of the sensor which detects movement is sufficient, all lights in the group will not be triggered on.

### 4.4 Manual Override

This sensor reserves the access of manual override function for end-user to switch on/off, or adjust the brightness by push-switch, which makes the product more user-friendly and offers more options to fit for some extra-ordinary demands:

- \* Short push (<1s): on/off function;  
 On → off: the light turns off immediately and can not be lightened for a certain time (equals to hold-time preset) even movement is detected. After this period, the sensor goes to sensor mode.  
 Off → on: the light turns on and goes to sensor mode, no matter if ambient Lux level exceeds the daylight threshold or not.
- \* Long push (>1s): dim up/down the hold-time brightness between 10% and 100%. Both the settings on DIP switch and manual override can overwrite each other, the latest action controls.

**Note:** if end-user do not want this manual override function, just leave the “push” terminal alone and don’t connect it to any wire.

### 4.5 Absence Detection Function

Motion sensor is employed, but only activated on the manual press of the push switch, light keeps on in the presence, and dimmed down in the absence, and eventually switch off in the long absence.

### 4.6 Daylight Monitoring Function

Hytronik specially design this function in software for deep energy-saving purpose. A built-in daylight sensor is designed to provide “smart photocell” function. This function can only be activated when stand-by period is set to “+∞”.

## Troubleshooting:

MALFUNCTION CAUSE REMEDY	CAUSE	REMEDY
The load does not work	Incorrect light-control setting selected	Adjust setting
	Load faulty	Replace load
	Mains switch OFF	Switch ON
The load is always on	Continuous movement in the detection zone	Check zone setting
The load is on without any identifiable movement	The sensor is not mounted for reliably detecting movement	Securely mount enclosure
	Movement occurred, but not identified by the sensor (movement behind wall, movement of small object in immediate lamp vicinity etc.)	Check zone setting
The load does not work despite movement	Rapid movements are being suppressed to minimize malfunctioning or the detection radius is too small	Check zone setting



## MaxLite® LED Low-Profile Garage & Canopy Luminaire

### Warranty Information

MaxLite Inc. warrants its products for a minimum period of **FIVE (5)** years from the date of original purchase from MaxLite or its authorized distributor/dealer (the “Warranty Period”), as follows: If a Product fails to operate during the Warranty Period as a result of defects in materials or workmanship, MaxLite will, at its option, repair it, replace it with the same or like Product.

Please refer to Maxlite’s website (at <http://maxlite.com/resources/warranties>) for the complete terms and conditions of our warranty.

#### Limitation of Liability

THE FOREGOING WARRANTY IS EXCLUSIVE, AND IS THE SOLE REMEDY FOR ANY AND ALL CLAIMS, WHETHER IN CONTRACT, IN TORT OR OTHERWISE ARISING FROM THE FAILURE OF PRODUCT AND IS IN LIEU OF ALL OTHER WARRANTIES, EXPRESS OR IMPLIED, INCLUDING ALL WARRANTIES OF MERCHANTABILITY OR FITNESS FOR A PARTICULAR PURPOSE, WHICH WARRANTIES ARE HEREBY EXPRESSLY DISCLAIMED TO THE EXTENT PERMITTED BY LAW AND, IN ANY EVENT, SHALL BE LIMITED TO THE WARRANTY PERIOD SPECIFIED ABOVE. THE LIABILITY OF MAXLITE SHALL BE LIMITED TO THE TERMS OF THE EXPRESS WARRANTY SET FORTH HEREIN. IN NO EVENT WILL MAXLITE BE LIABLE FOR ANY SPECIAL, INCIDENTAL OR CONSEQUENTIAL DAMAGES INCLUDING, WITHOUT LIMITATION, DAMAGES RESULTING FROM LOSS OF USE, PROFITS, BUSINESS OR GOODWILL, LABOR COSTS, REMOVAL OR INSTALLATION COSTS, DECREASE IN THE LIGHT OUTPUT OF THE LAMP, AND/OR DETERIORATION IN THE LAMP’S PERFORMANCE, WHETHER OR NOT MAXLITE HAS BEEN ADVISED OF THE POSSIBILITY THEREOF. UNDER NO CIRCUMSTANCES SHALL MAXLITE’S ENTIRE LIABILITY FOR A DEFECTIVE PRODUCT EXCEED THE PURCHASE PRICE OF THAT PRODUCT. WARRANTY SERVICES PROVIDED UNDER THESE TERMS AND CONDITIONS DO NOT ENSURE THE UNINTERRUPTED OPERATION OF PRODUCTS; MAXLITE SHALL NOT BE LIABLE FOR DAMAGES CAUSED BY ANY DELAYS INVOLVING WARRANTY SERVICE.

This Limited Warranty gives you specific legal rights and you may also have other rights that may vary from state to state. Because some states or jurisdictions do not allow the exclusion or limitation of liability for consequential or incidental damages, this limitation may not apply to you.