

# LEDVANCE Luminaires

## SLIM CCT SELECTABLE MICRODISK

PERFORMANCE CLASS™

### Application

The LEDVANCE Performance Class Slim CCT Selectable Microdisk is a slim profile LED downlight kit with remote driver that at either 120VAC or 120-277VAC. The 1/2" height allows for installation directly under joists in new and remodel construction.

### Benefits and Features

- High CRI (>90) ensures a high quality light
- 1/2" height facilitates installations in most residential applications
- IC Rated for contact with ceiling insulation
- All necessary quick connectors are included with each SKU
- Up to 87 LPW
- 2700K, 3000K, 3500K, 4000K, 5000K color temperature selectable via the switch located on the driver
- Offered in 6.5, 10, 14, 19, and 23 watt versions
- Energy savings up to 92%

### Electrical

- Offered in 120V or 120-277V (see ordering guide for further details)
- Power Factor >0.9
- THD <20%
- Offered in Phase-Cut dimming and 0-10V dimming models (see ordering guide for further details)

### Rated Life

- 50,000 hours (L<sub>90</sub>)

### Warranty

- 5-year
- NLB Trusted Warranty Program

### Ambient Operating Range

- -4°F to +104°F (-20°C to +40°C)

### Installation

- For installation into 3", 4", 6", 8" and 12" ceiling cut-outs.
- Universal Metal Frame sold separately as accessory for new construction: fits all sizes in Slim MICRODISK portfolio.
- Quick connectors are included in the box with purchase of each SKU



### Wattage Comparison

Traditional Source	LED System Wattage	Energy Savings
100W BR40	6.5W	85%
120W Incandescent	10W	88%
23W CFL	14W	30%
32W CFL	19W	63%
40W CFL	23W	48%

### Certifications and Listings

- cETLus
- RoHS
- FCC
- Title 24 Compliant
- TAA
- ENERGY STAR®
- Suitable for wet locations
- FT6 listed cable
- Suitable for use in closets, compliant with NFPA 70, NEC section 410.16 (A)(3) and 410.16 (C)(5)



Catalog #	Type
Project	
Comments	
Prepared by	

**Ordering Guide**

<b>LEDMD</b>	<b>XR</b>	<b>3A</b>	<b>/</b>	<b>XXXX</b>	<b>XXX</b>	<b>X</b>	<b>9</b>	<b>SC3</b>	<b>/</b>	<b>XX</b>
Product Name	Dimensions	Generation		Lumens	Voltage	Dimming	CRI	CCT		Color/Finish
LEDMD = LED Slim	3R = 3" Round	3A = Generation 3A		500 = 500 Lumens	S = 120V	T = Triac Dimming	9 = >90	SC3 = 2700/3000/ 3500/4000/5000K		WH = White Finish BL = Black Finish
MICRODISK	4R = 4" Round			800 = 800 Lumens	UNV = 120-277V	D = 0-10V Dimming				
	6R = 6" Round			1200 = 1200 Lumens						
	8R = 8" Round			1600 = 1600 Lumens						
	12R = 12" Round			2000 = 2000 Lumens						

**Ordering Information**

Item Number	Ordering Abbreviation	Power (W)	Total Fixture Lumens		Input Voltage	Dimming	CRI	Color Temp (CCT)	ENERGY STAR®	IC Rated	MTO*
			(lm)	LPW							
63053	LEDMD3R3A/500ST9SC3/WH	6.5	550	84	120V	Phase-cut	>90	2700/3000/3500/4000/5000K	Yes	Yes	–
63059	LEDMD4R3A/800ST9SC3/BL	10	820	82	120V	Phase-cut	>90	2700/3000/3500/4000/5000K	Yes	Yes	–
63054	LEDMD4R3A/800ST9SC3/WH	10	820	82	120V	Phase-cut	>90	2700/3000/3500/4000/5000K	Yes	Yes	–
63055	LEDMD6R3A/800ST9SC3/WH	10	820	82	120V	Phase-cut	>90	2700/3000/3500/4000/5000K	Yes	Yes	–
63060	LEDMD6R3A/800ST9SC3/BL	10	820	82	120V	Phase-cut	>90	2700/3000/3500/4000/5000K	Yes	Yes	–
63056	LEDMD6R3A/1200ST9SC3/WH	14	1200	86	120V	Phase-cut	>90	2700/3000/3500/4000/5000K	Yes	Yes	–
63057	LEDMD8R3A/1600ST9SC3/WH	19	1600	84	120V	Phase-cut	>90	2700/3000/3500/4000/5000K	Yes	Yes	–
63058	LEDMD12R3A/2000ST9SC3/WH	23	2000	87	120V	Phase-cut	>90	2700/3000/3500/4000/5000K	No	Yes	–
63598	LEDMD4R3A800UNVD9SC3/WH	10	820	82	120-277V	0-10V	>90	2700/3000/3500/4000/5000K	Yes	Yes	MTO
63599	LEDMD6R3A800UNVD9SC3/WH	14	820	82	120-277V	0-10V	>90	2700/3000/3500/4000/5000K	Yes	Yes	MTO
63600	LEDMD6R3A1200UNVD9SC3/WH	14	1200	86	120-277V	0-10V	>90	2700/3000/3500/4000/5000K	Yes	Yes	MTO
63601	LEDMD8R3A1600UNVD9SC3/WH	19	1600	84	120-277V	0-10V	>90	2700/3000/3500/4000/5000K	Yes	Yes	MTO
63603	LEDMD4R3A800UNVD9SC3/BL	10	820	82	120-277V	0-10V	>90	2700/3000/3500/4000/5000K	Yes	Yes	MTO
63604	LEDMD6R3A800UNVD9SC3/BL	10	820	82	120-277V	0-10V	>90	2700/3000/3500/4000/5000K	Yes	Yes	MTO

\*Made to Order

**Compatible Phase-Cut Dimmers**

Make	Leading or Trailing Edge	Model
Leviton SureSlide	L	6674
Lutron Maestro C-L	L	MACL-153M
Lutron Diva	L	DVCL-153P
Lutron Caseta	L	PD-6WCL
Legrand Radiant	L	RHCL453P
Lutron Diva	T	DVELV-300P
Lutron Maestro	T	MAELV-600

**Compatible 0-10V Dimmers**

Make	Type	Model
Leviton	0-10V	DS710
Leviton	0-10V	IP710
Lutron	0-10V	NTSTV-DV
Lutron	0-10V	DVSTV
Lutron	0-10V	DVTV-WH
Legrand	0-10V	H4FBL3PW

## Photometric Information

6.5W 3"

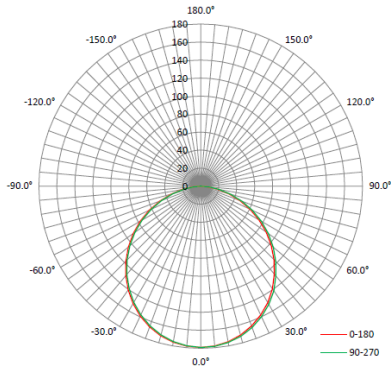

10W 4"

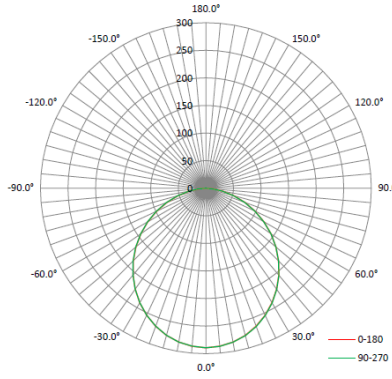

10W 6"

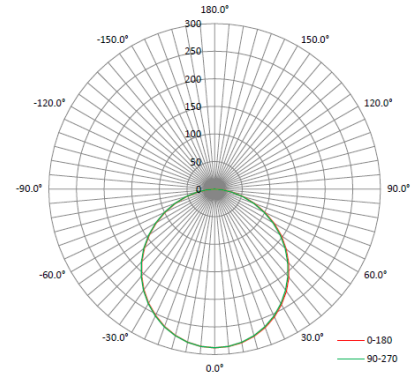

14W 6"

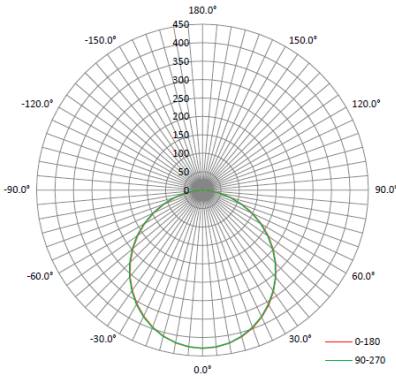

19W 8"

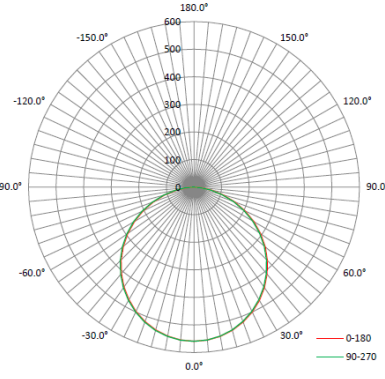

23W 12"

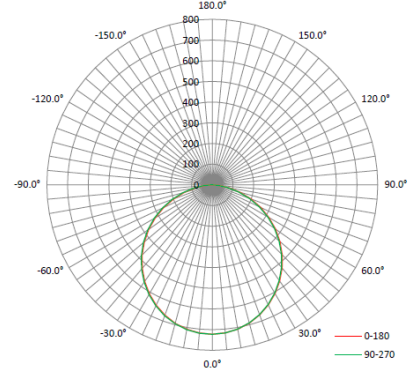

## Physical Information

Lamp Description	Diameter (in)	Height (in)
3R = 3" round	4.33	0.69
4R = 4" round	5.28	0.69
6R = 6" round	7.32	0.69
8R = 8" round	9.49	0.69
12R = 12" round	13.5	0.69

3 inch

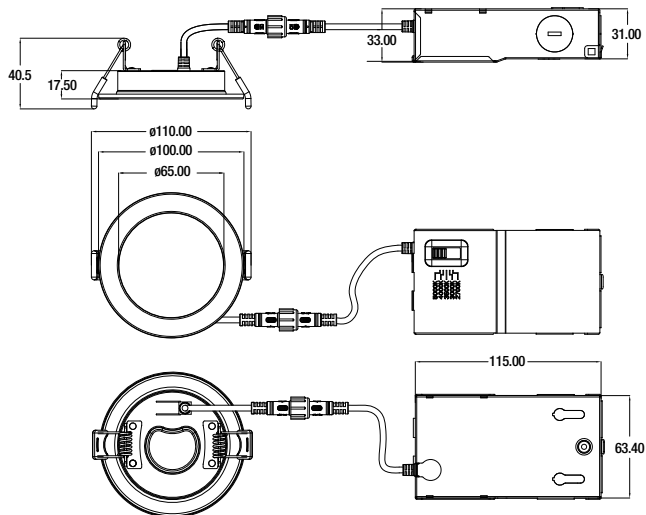

4 inch

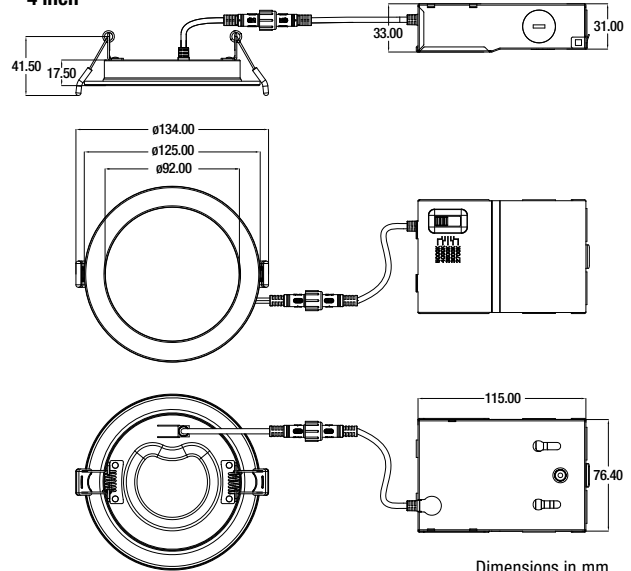

Dimensions in mm

## Physical Information (continued)

### 6 inch

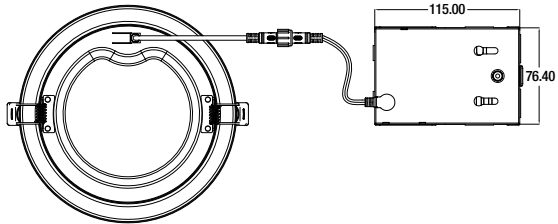
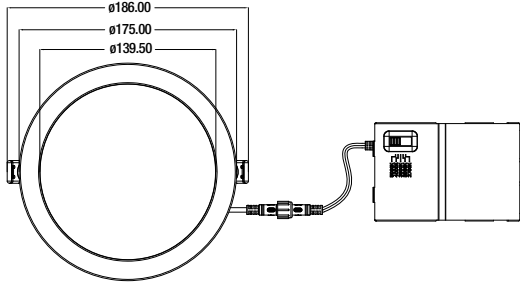
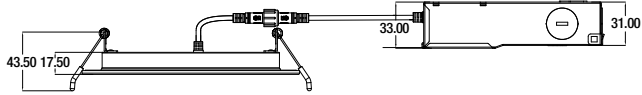

### 8 inch

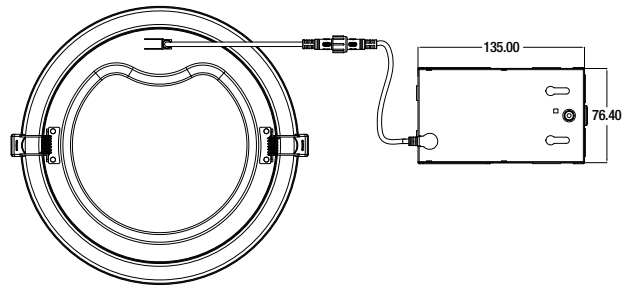
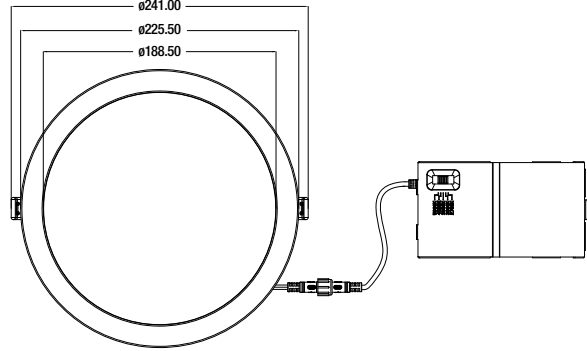
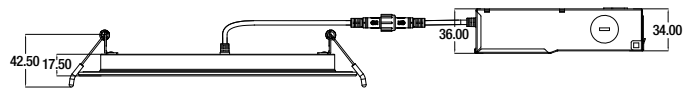

### 12 inch

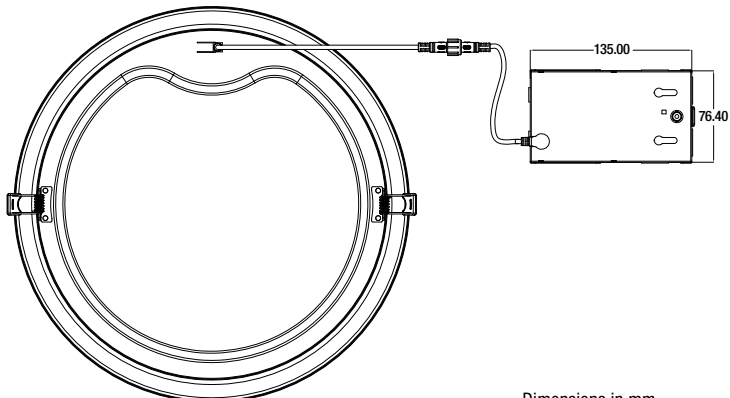
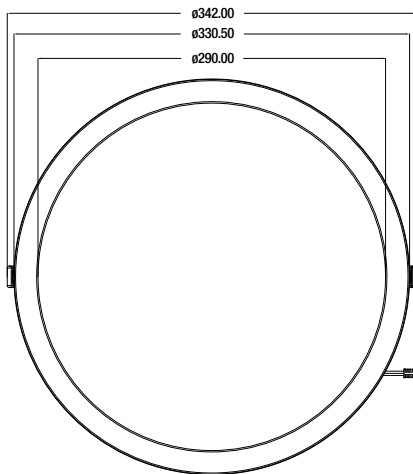
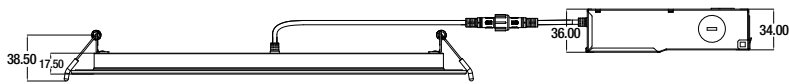

Dimensions in mm

## Accessories

Item Number	Ordering Abbreviation	Item Description
63202	SLIMMD3A3/TRIMBLK	Black trim for 3" models
63203	SLIMMD3A3/TRIMBZ	Bronze trim for 3" models
63204	SLIMMD3A3/TRIMSN	Satin nickel trim for 3" models
63205	SLIMMD3A4/TRIMBLK	Black trim for 4" models
63206	SLIMMD3A4/TRIMBZ	Bronze trim for 4" models
63207	SLIMMD3A4/TRIMSN	Satin nickel trim for 4" models
63208	SLIMMD3A6/TRIMBLK	Black trim for 6" models
63209	SLIMMD3A6/TRIMBZ	Bronze trim for 6" models
63210	SLIMMD3A6/TRIMSN	Satin nickel trim for 6" models
63211	SLIMMD3A8/TRIMBLK	Black trim for 8" models
63212	SLIMMD3A8/TRIMBZ	Bronze trim for 8" models
63213	SLIMMD3A8/TRIMSN	Satin nickel trim for 8" models
63214	SLIMMD3A12/TRIMBLK	Black trim for 12" models
63215	SLIMMD3A12/TRIMBZ	Bronze trim for 12" models
63216	SLIMMD3A12/TRIMSN	Satin nickel trim for 12" models

Item Number	Ordering Abbreviation	Length	Width
60793	LEDMD6FTEXCBL	6ft	-
60794	LEDMD10FTEXCBL	10ft	-
60795	LEDMD20FTEXCBL	20ft	-
62959	LEDSLIMMDFRAME	20.72in (526mm)	9.65in (2450mm)

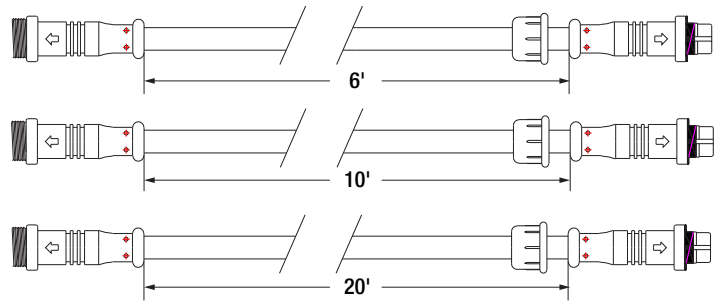

## Metal Frame

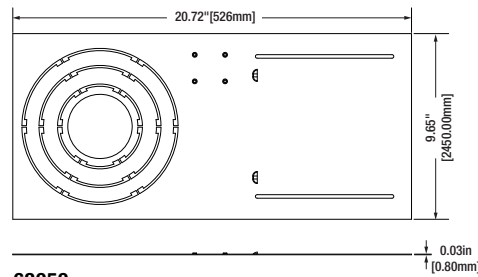
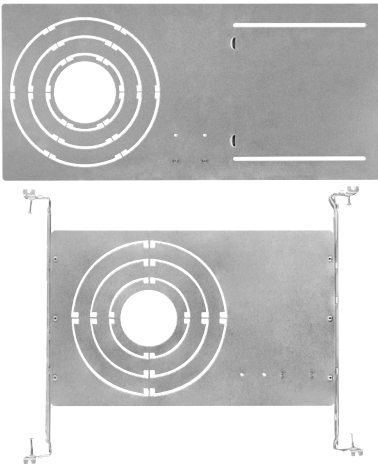

62959

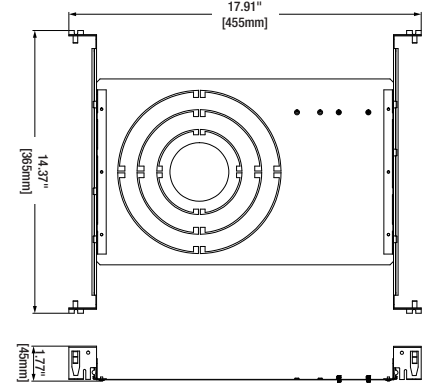

63743

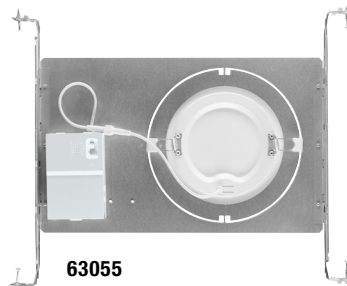

63055

## Hole Cut Templates

### MD3 Hole Cut Template

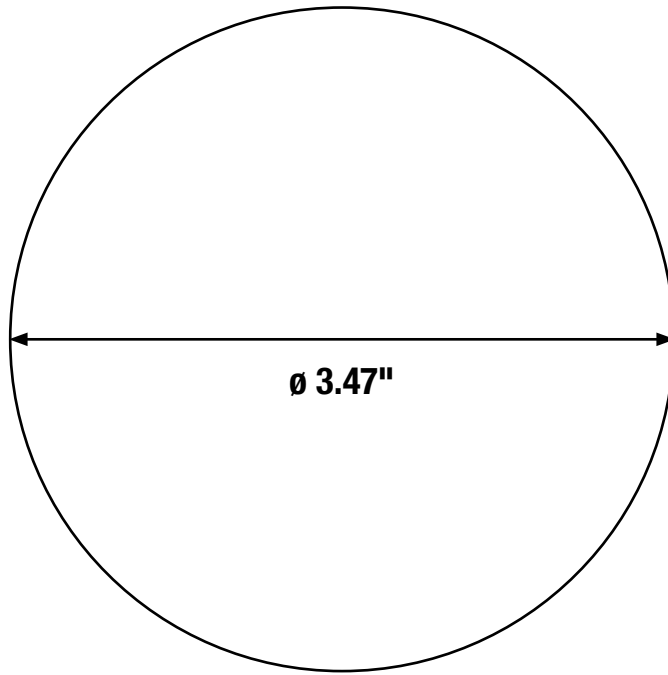

### MD4 Hole Cut Template

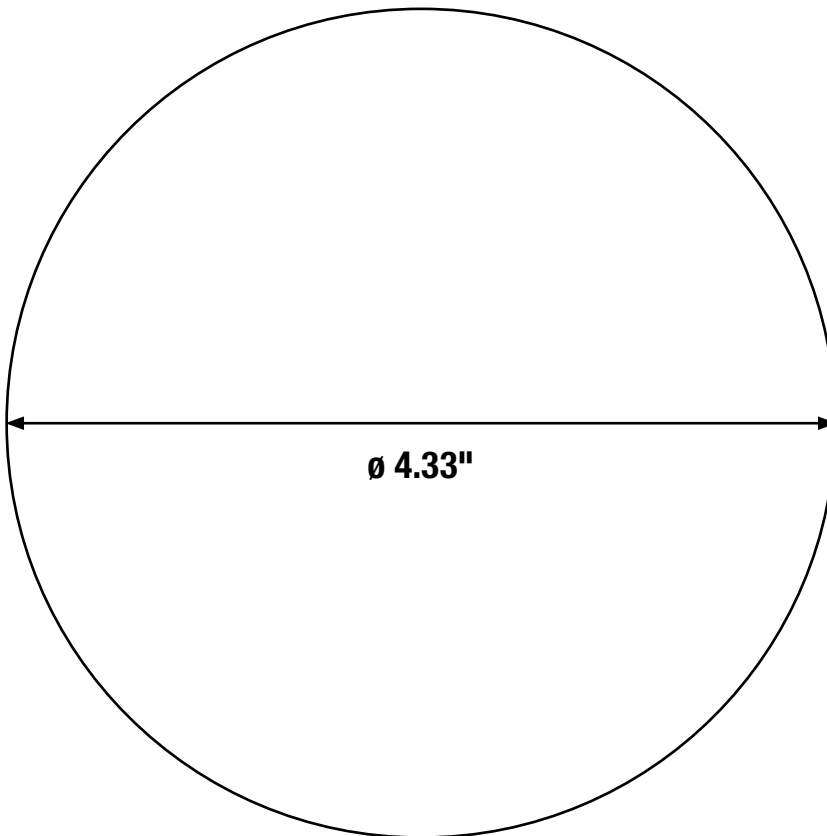

**Hole Cut Templates**

**MD6 Hole Cut Template**

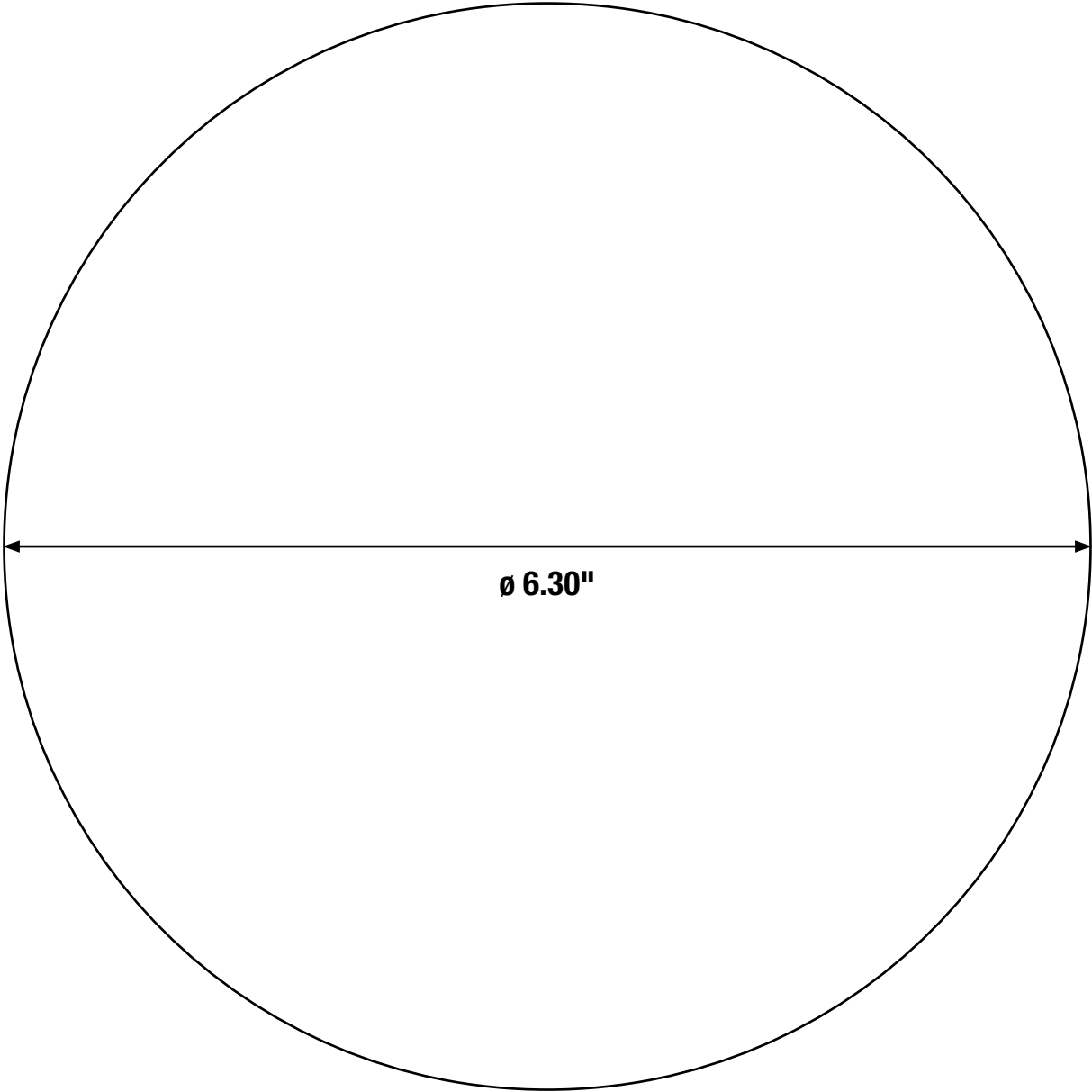

**Hole Cut Templates**

**RT8 Hole Cut Template**

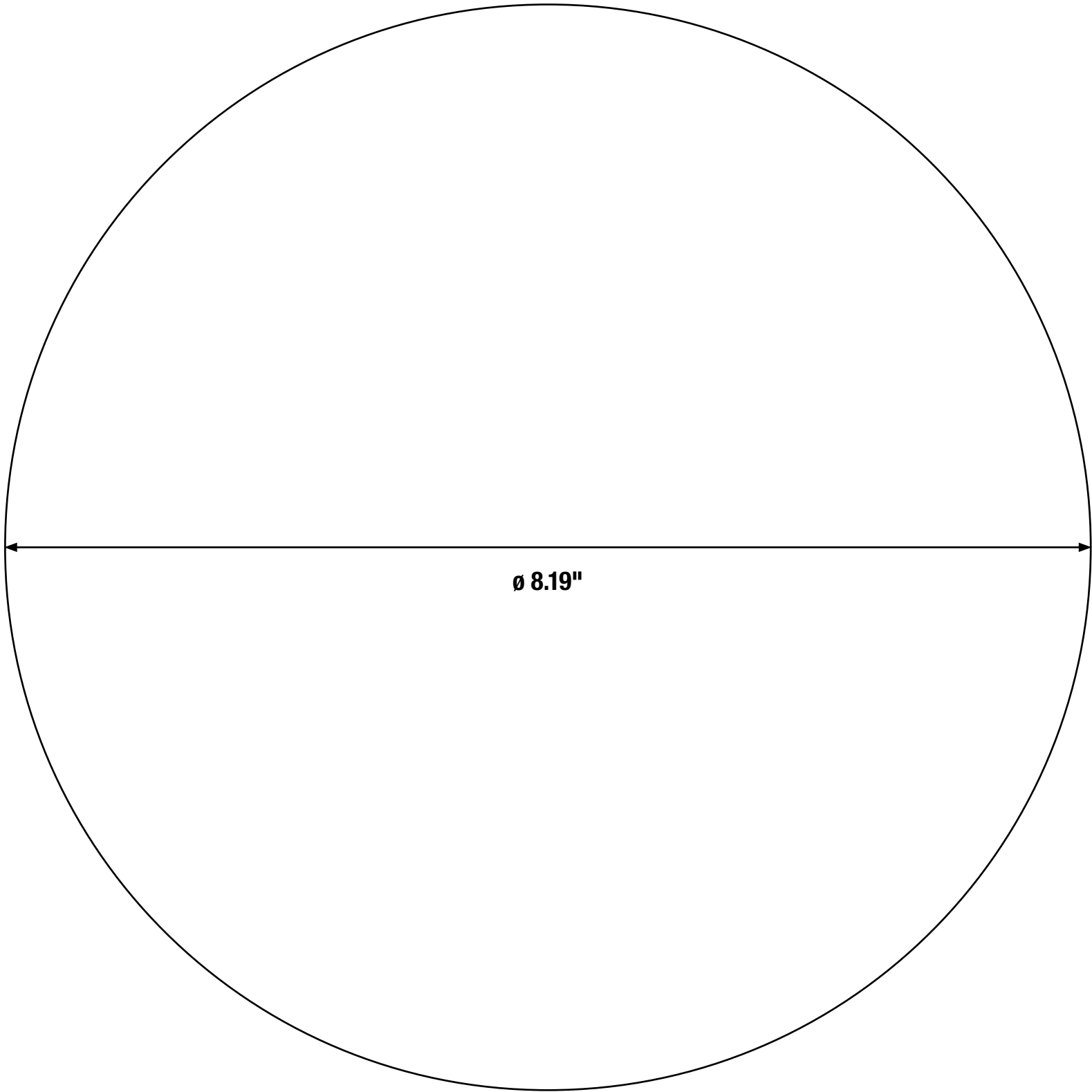



LEDVANCE LLC  
181 Ballardvale Street, Suite 203  
Wilmington, MA 01887 USA  
Phone 1-800-LIGHTBULB (1-800-544-4828)  
[www.ledvanceUS.com](http://www.ledvanceUS.com)

LEDVANCE is a registered trademark.  
All other trademarks are those of their respective owners.  
Specifications subject to change without notice.



SCAN TO FOLLOW US  
ON SOCIAL MEDIA

